

Einführung in die Erweiterte Realität

9. Mixed Reality, Information Presentation

Prof. Gudrun Klinker, Ph.D.

Institut für Informatik, Technische Universität München

klinker@in.tum.de

Jan 11, 2005

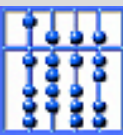

Agenda

1. A Taxonomy of Real and Virtual World Display Integration (Paul Milgram & Herman Colquhoun Jr, ISMR'99)
2. Augmented maintenance of powerplants: A prototyping case study of a mobile AR system (Klinker et al, ISAR'01)

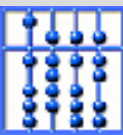

What is Augmented Reality ???

Augmented Reality

Occluded Reality

Diminished Reality

Reality Models

Virtual Studios
Virtual Models

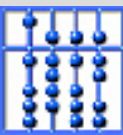

What is Augmented Reality ???

- Augmentations shown in HMDs (“classical AR”).
- Augmentations shown on other displays (“any case in which an otherwise real environment is augmented by means of virtual objects”).
- Any mixture of real and virtual environments.

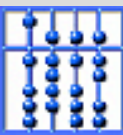

Reality-Virtuality Continuum

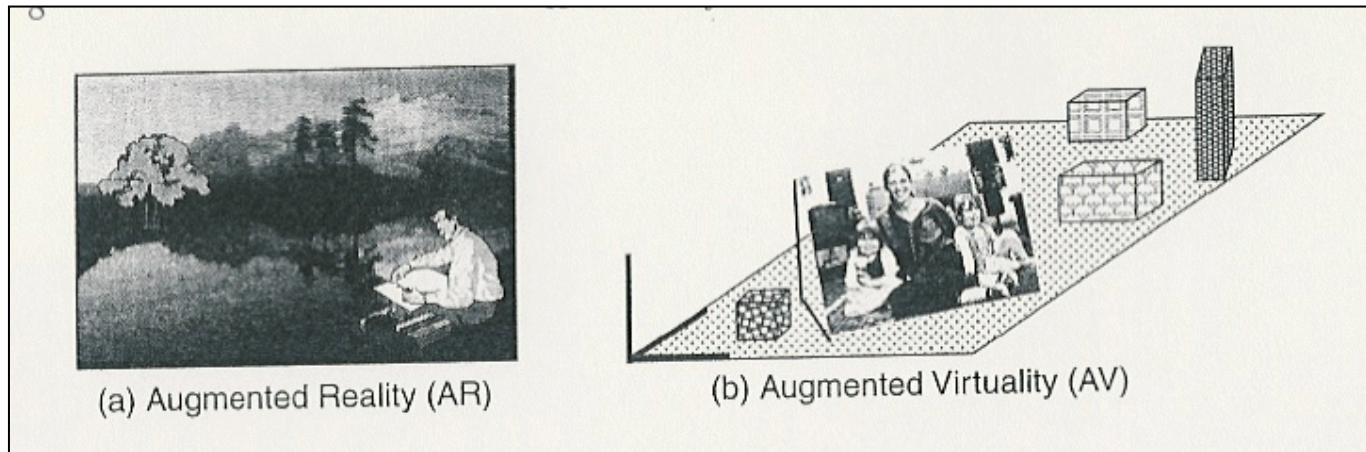
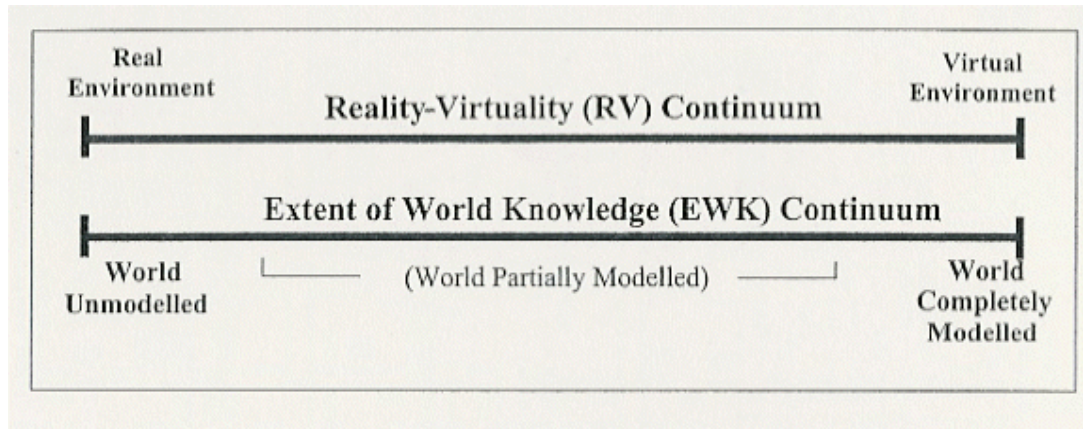

Reality-Virtuality Continuum

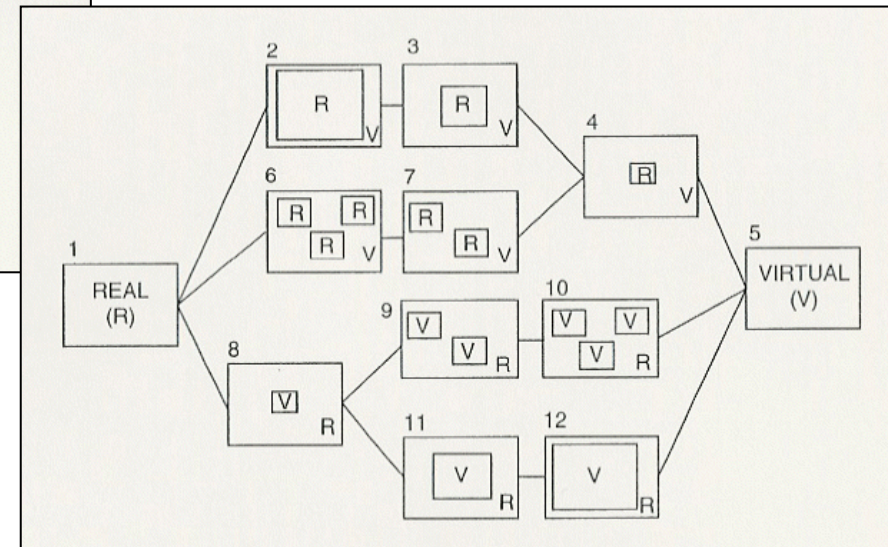
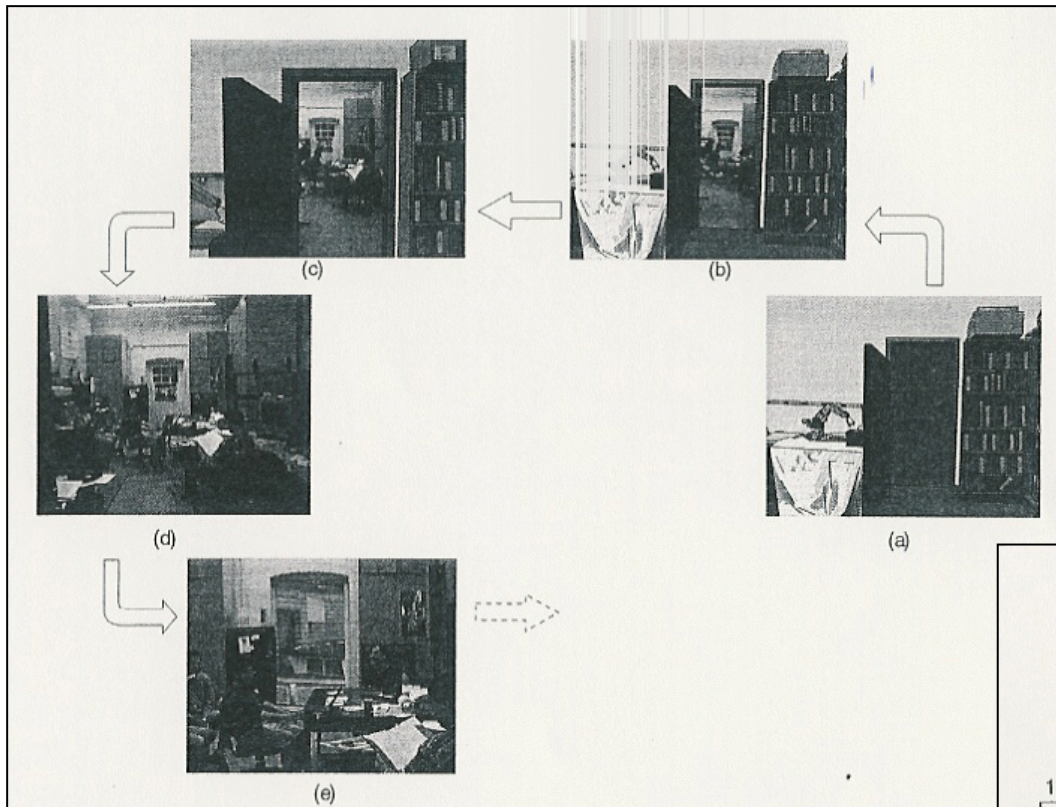

Mixed Reality

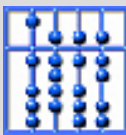
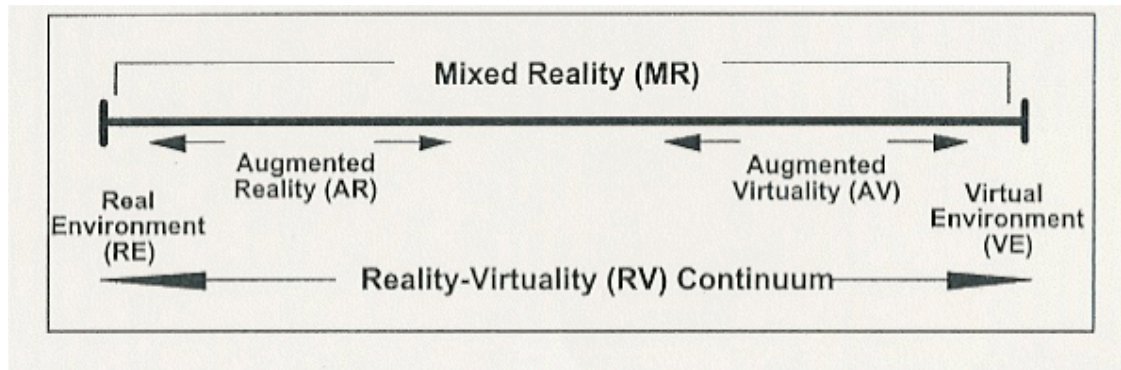

Display Centricity

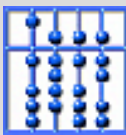
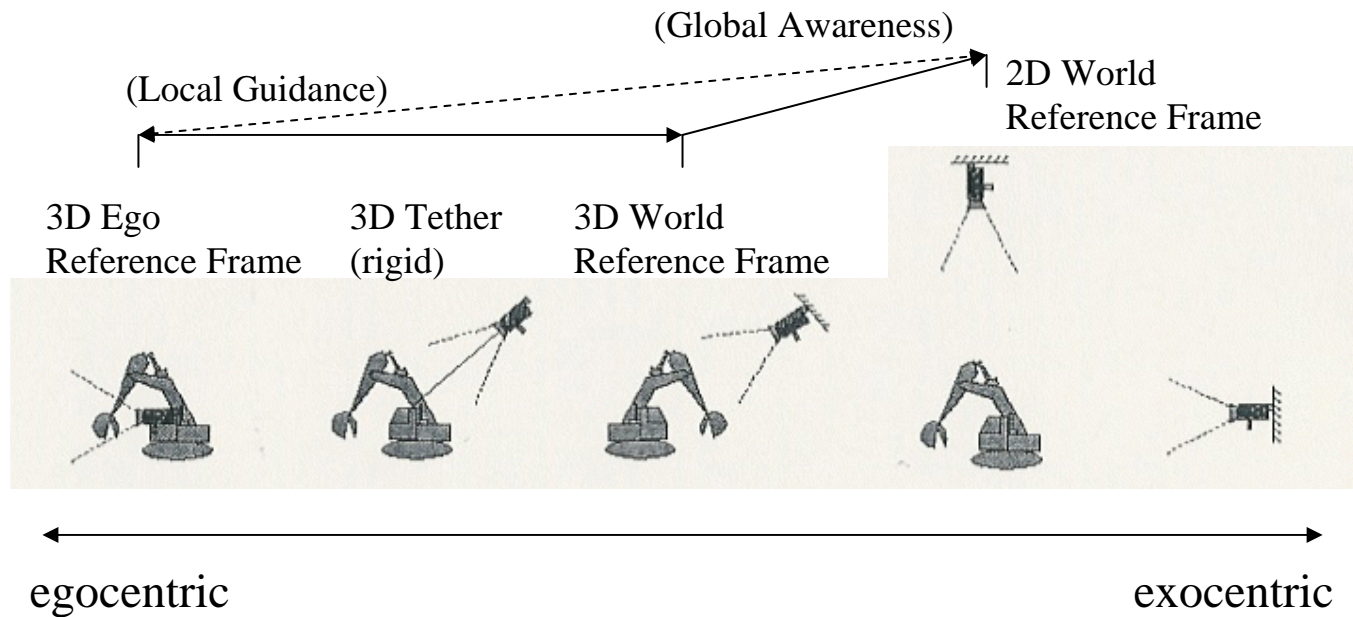

Control-Display Mapping

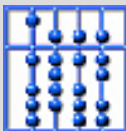
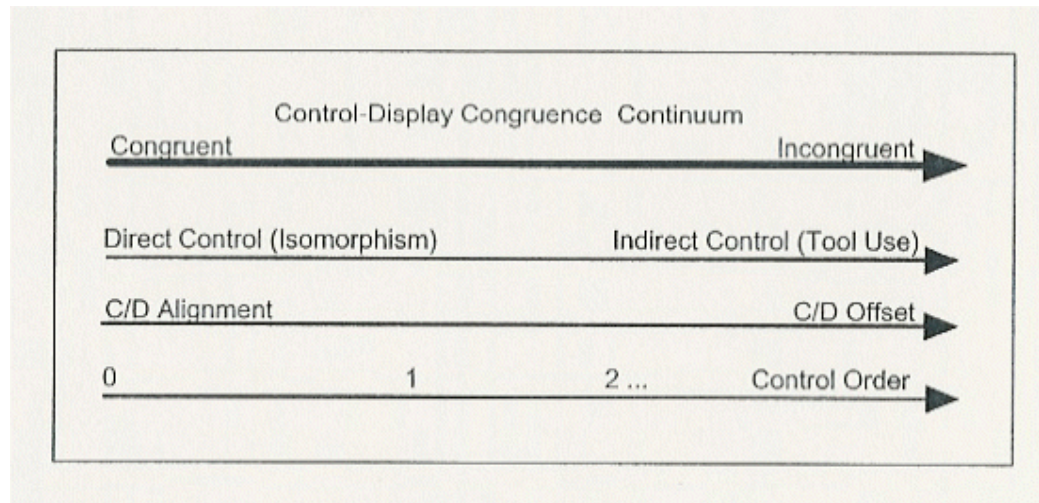

Control-Display Mapping

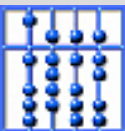
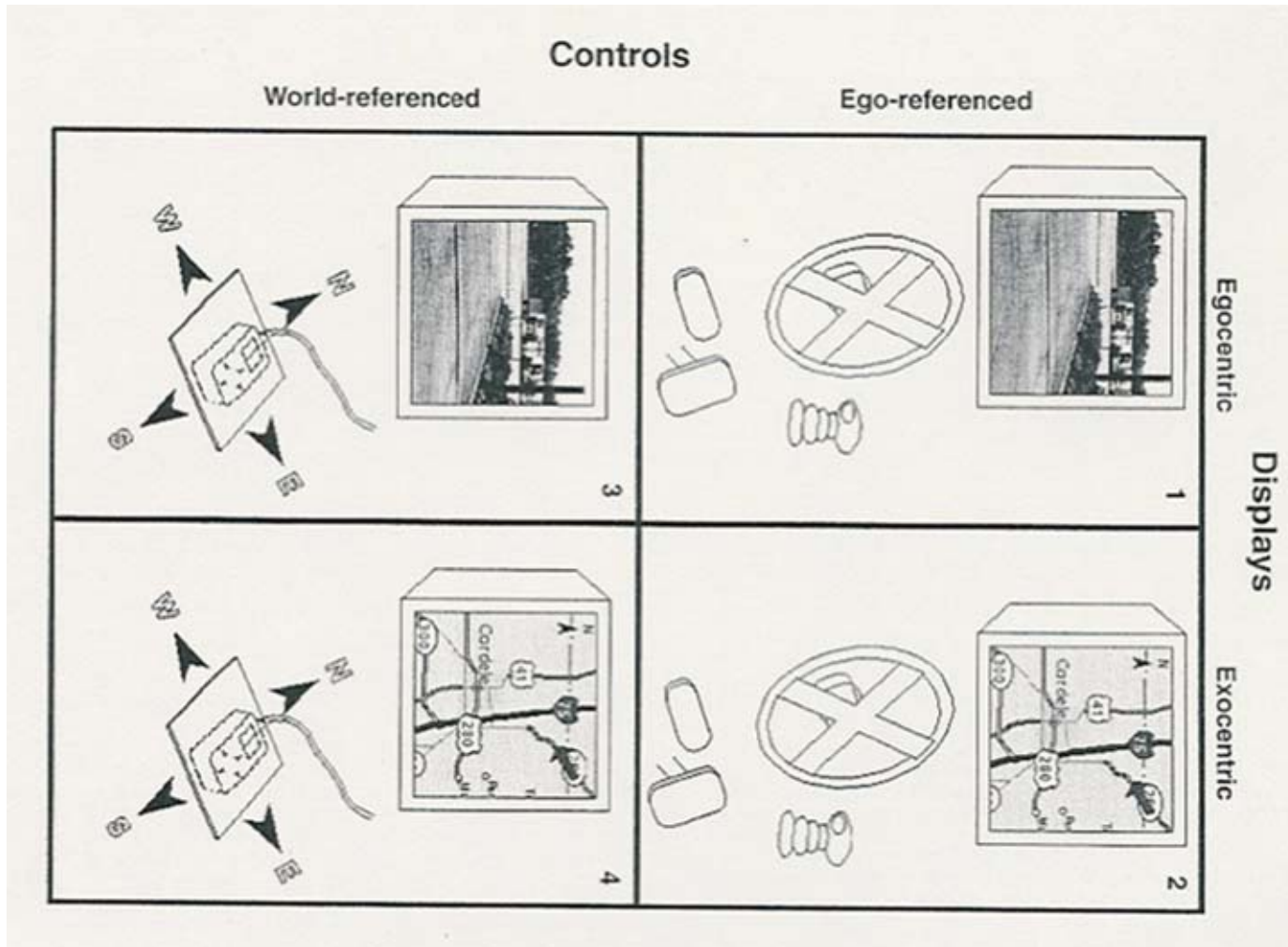

AR Taxonomy

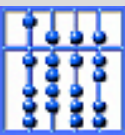

Sample applications

- Local AR (with HMD)
- Navigational AR (with HMD)
- AR Telerobotics
- Minimally invasive surgery
- AV web pages

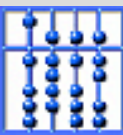

AR Taxonomy

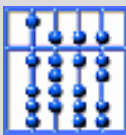
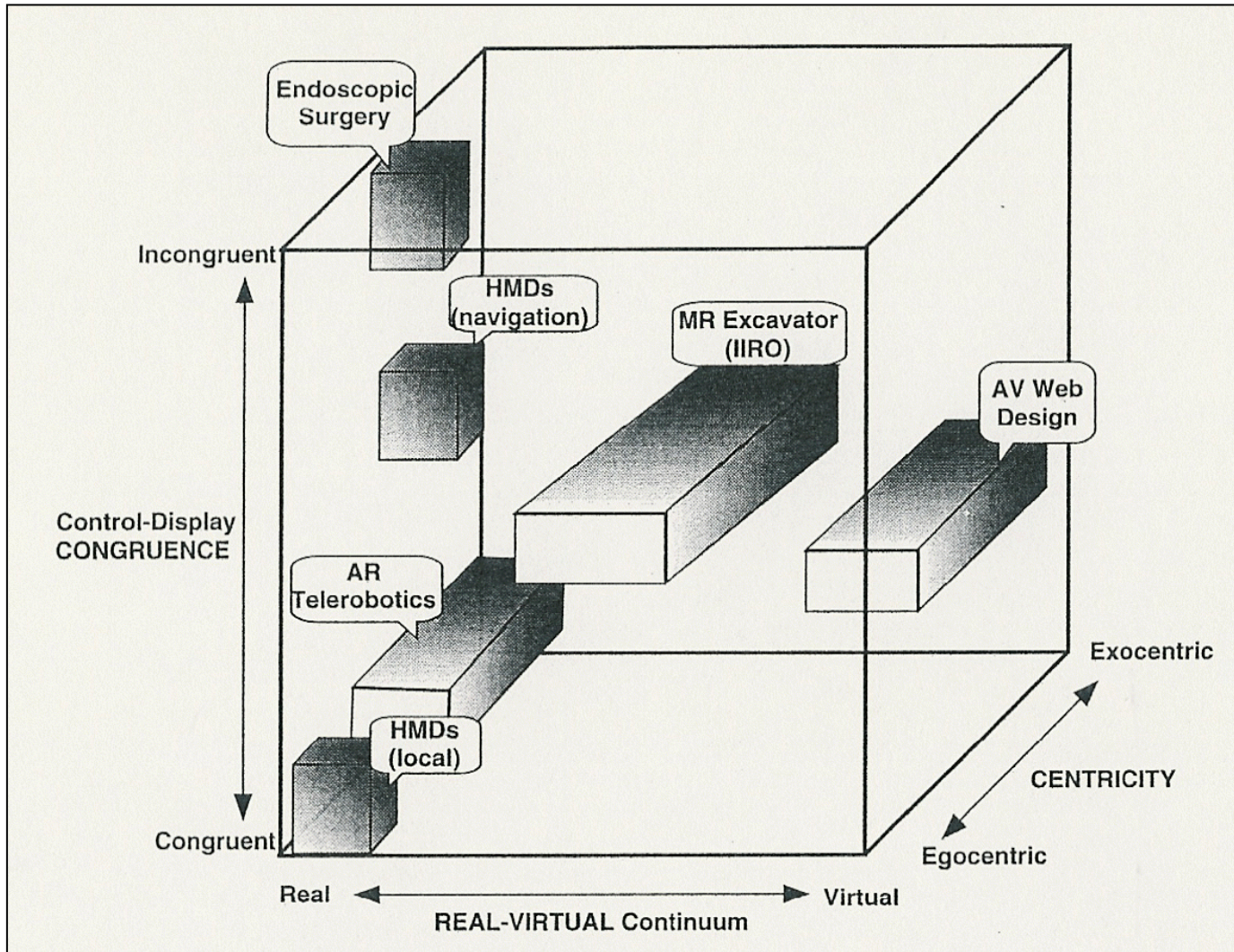

STARS:

Augmented Maintenance of Powerplants: A Prototyping Case Study of a mobile AR system

G. Klinker, O. Creighton, A.H. Dutoit, R. Kobilinsky, C. Vilsmeier,
B. Bruegge

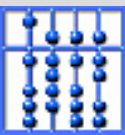

Outline

- Goals & approach
- Motivation
- Problem domain
 - Current situation
 - Visionary situation
- STARS architecture
- Results
- Lessons learned

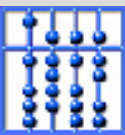

Goals & Approach

Long term goal:

- Provide an AR framework enabling information system developers to reuse and adapt AR components to their application domain.

Approach

- Conduct a series of case studies, prototyping with real clients visionary AR applications.
- Improve framework with lessons learned.

This presentation

- STARS case study in nuclear power plant maintenance (“Praktikum” at CMU and TU Munich).

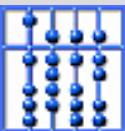

Motivation

- Industrial settings of mobile AR systems introduce new issues in information systems:
 - Information storage and modeling
 - Transmission of information to the user
 - Visualization of massive information
- Current research focus in AR typically on:
 - Robust tracking
 - 3D graphics with HMD
- Related work:
 - Feiner et al.
 - Curtis et al.
 - ARVIKA

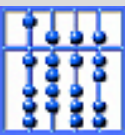

Problem domain: Nuclear powerplants

Conflicting criteria:

- Regulation compliance, safety
- Cost
- Parallel work

Highly encoded preventive maintenance procedure

Current system is paper-based

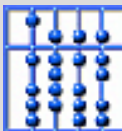
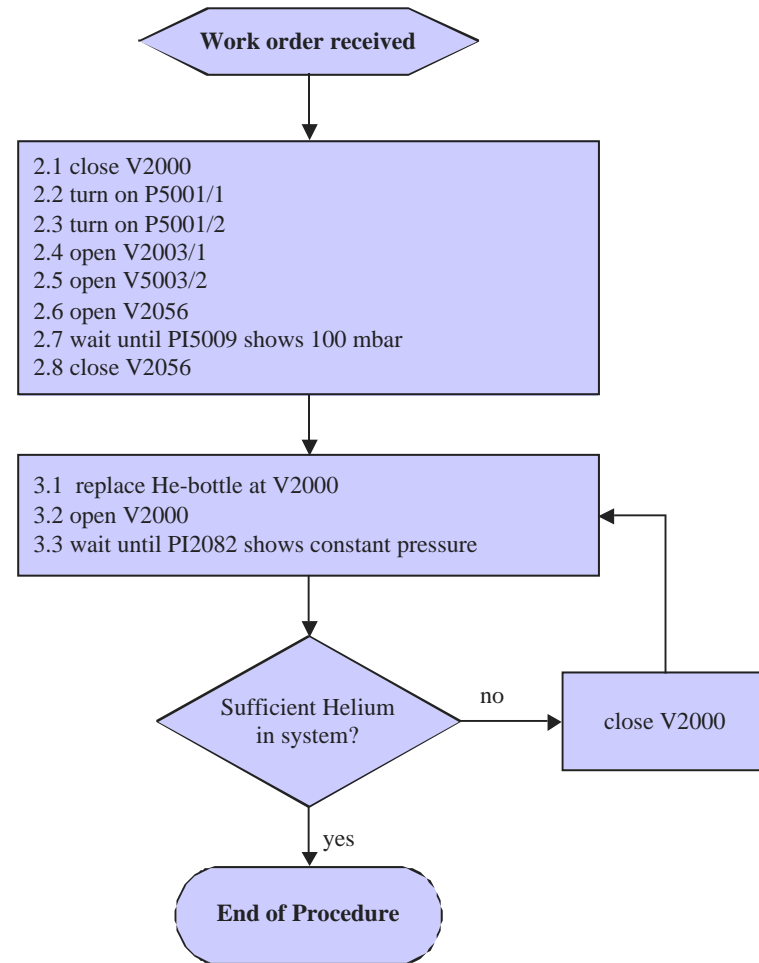

Current situation



He-System bis zu den geschlossenen Ventilen evakuieren,
dazu

Ventil, H	V2000	ZU	<u>Vor F-Bau I</u>	
Vakuumpumpe	P5001/1	EIN	G-Haus	_____
Vakuumpumpe	P5001/2	EIN	G-Haus	_____
Ventil, H	V5003/1	AUF	G-Haus	_____
Ventil, H	V5003/2	AUF	G-Haus	_____
Ventil, H	V2056	AUF	G-Haus	_____

Warten (evakuieren) bis
Druckanzeige an

Meßstelle (Evakuier-Sammelleitung)	PI5009	$1 \cdot 10^{-1}$ bar abs	G-Haus	_____
dann				
Ventil, H	V2056	ZU	G-Haus	_____

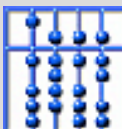

Visionary situation: IETMs

- Interactive Electronic Technical Manuals
- Hierarchical, executable procedures, analog to a computer program.
- Steps are organized in conditional statements and in loops.
- Already used in aircraft maintenance.

The screenshot displays a hierarchical XML structure for a technical manual. The root element is 'techinfo', which contains a 'system' element. The 'system' element has a 'task' element, which in turn contains a 'step-seq' element. The 'step-seq' element contains a list of steps, with the first three steps (id2, id3, id4) grouped under a 'loop-step' element. The 'loop-step' element contains three 'expression' elements (id411, id412, id413) and a 'step-seq' element (id420). The 'step-seq' element contains a single step (id5). The 'partinfo' element contains a 'name' (helium), an 'id' (id61), a 'partbase' (partnum=He id=id6 name=helium bottle), and a 'location' (id=id61D01 locallon-x=42 locallon-y=5).

XML		
DOCTYPE	techinfo	
techinfo		
id	id1	
name	Helium Flushing System	
starttopic	id100	
system		
id	id10	
name	Helium Flushing System	
task		
id	id100	
name	Bimonthly Check of Helium Flushing System	
step-seq (4)		
id	step	
loop-step		
1	id2	step (0)
2	id3	step (3)
3	id4	
loop-step		
id	id41	
expression		
id	id410	
expression	id=id411	
id	id412	
expression	id=id413	
step-seq	id=id420	
4	id5	step (1)
partinfo		
name	helium	
id	id61	
partbase	partnum=He id=id6 name=helium bottle	
location	id=id61D01 locallon-x=42 locallon-y=5	

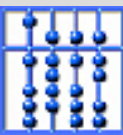

Visionary situation: HMDs

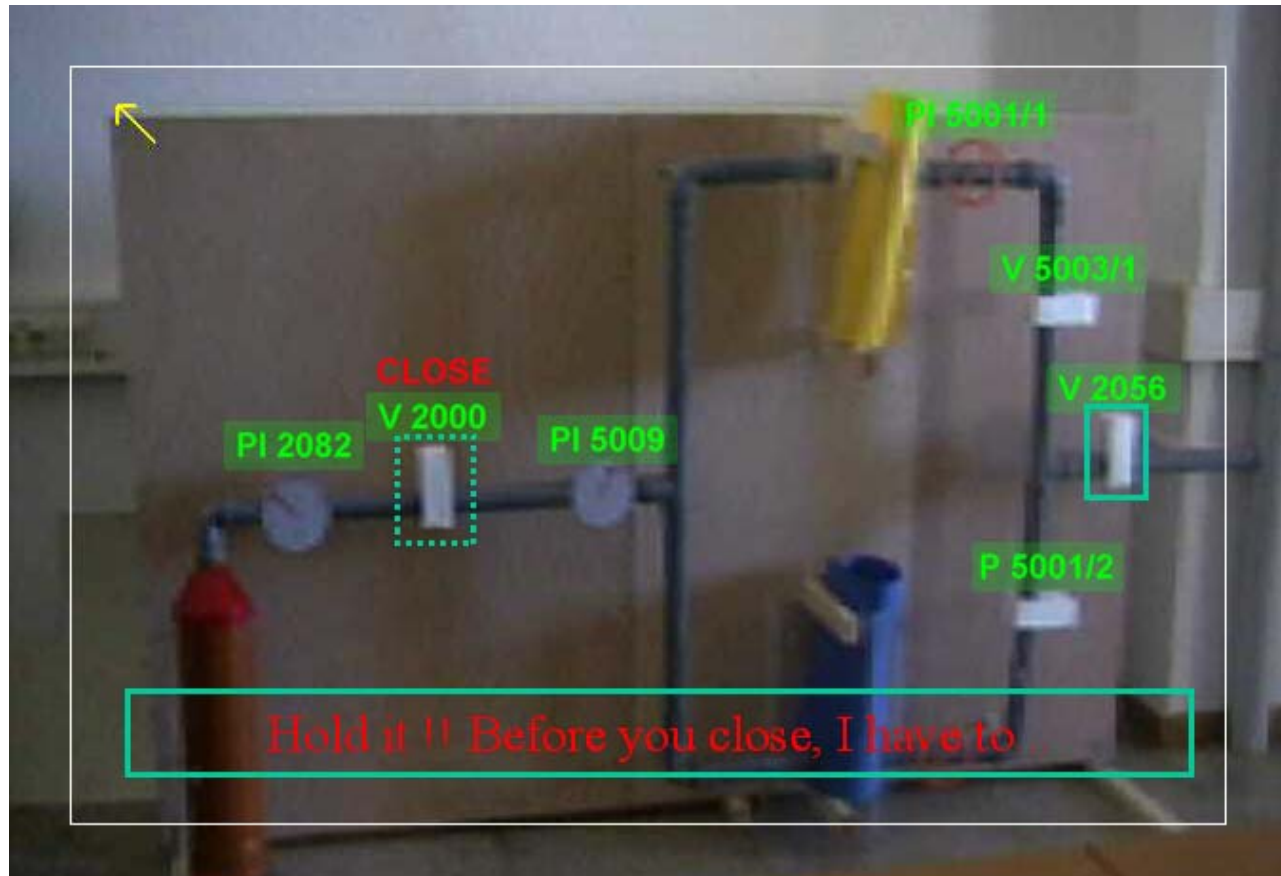

- The technician wears an HMD
- Augmentations indicate device IDs
- Individual devices involved in the procedure are emphasized.

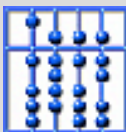

Visionary situation: LCD

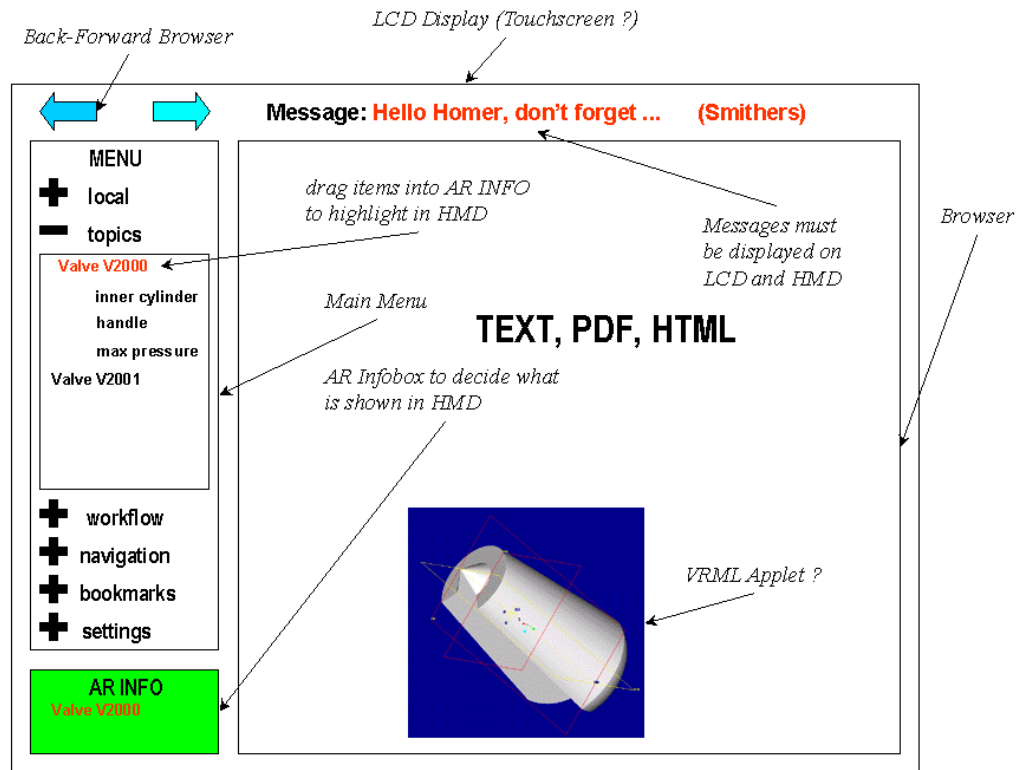

- High density information is displayed on an LCD plate
- The HMD display can be flipped up to enable the technician to examine the LCD plate.
- The LCD plate is stowed away when not needed.

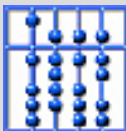

Constraints & Challenges

- Wireless network
 - Mobile client should be able to function, even in the absence of a network connection
- Multimodal user interface
 - User must be able to select a user interface mode most appropriate to its work and environment
 - Speech, AR, LCD-plate, mouse, [smartcard, iButton]
- Legacy information
 - Current maintenance manuals are on paper
 - Need to be converted into IETMs
 - Need to be related with geometrical world model

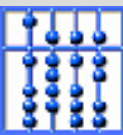

STARS Architecture

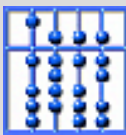
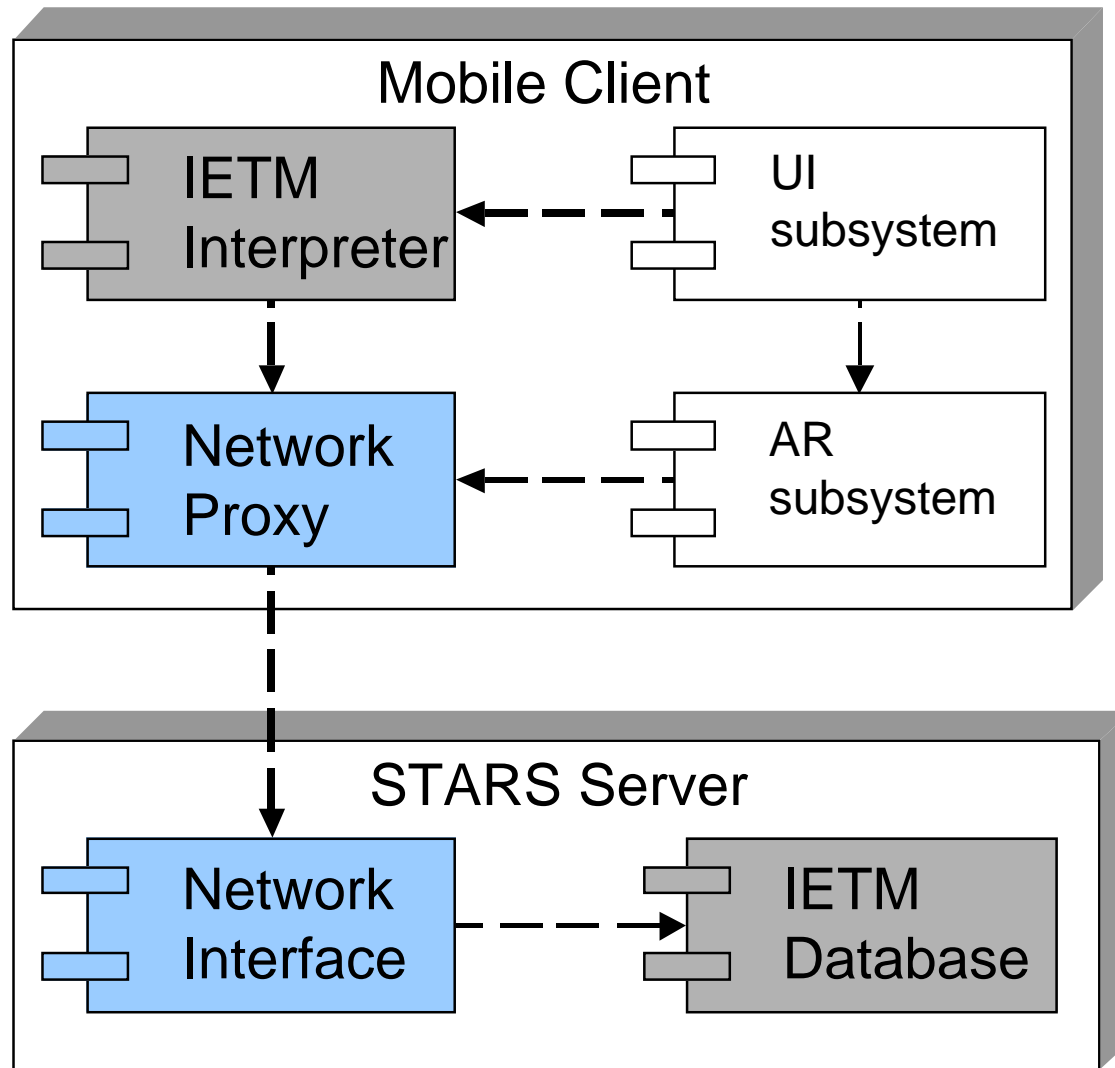

STARS Subsystems

IETM

- Interpreter is separated from the database and runs on client
- Enables execution of procedure in the absence of connection

Network

- Transparent retrieval of IETMs and supporting material (video, audio, etc.)
- Prefetch and caching based on:
 - Location
 - Work order
 - statistical analysis of history

User Interface/AR

- Tsai tracking
- High-level commands between UI and AR

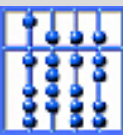

STARS Subsystems: IETMS (Interactive Electronic Technical Manuals)

- Specification by DoD (SGML or XML)
 - MIL-M-87268: behave and look
 - MIL-M-87269: database spec & DTD
- in STARS: XML formatted IETMS (DTD derived from 87269)

```
XML
DOCTYPE techinfo
techinfo
  id id1
  name Helium Flushing System
  starttopic id100
  system
    id id10
    name Helium Flushing System
    task
      id id100
      name Bimonthly Check of Helium Flushing System
      step-seq (4)
        id id2 step loop-step
        1 id2 step (0)
        2 id3 step (3)
        3 id4
        loop-step
          id id41
          expression
            id id410
            expression id id411
            lt id id412
            expression id id413
          step-seq id id420
        4 id5 step (1)
    partinfo
      name helium
      id id61
      partbase partnum=He id=id6 name=helium bottle
      location id=id61001 location-x=42 location-y=9
```

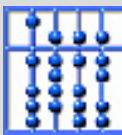

STARS Subsystems: IETMS Overview

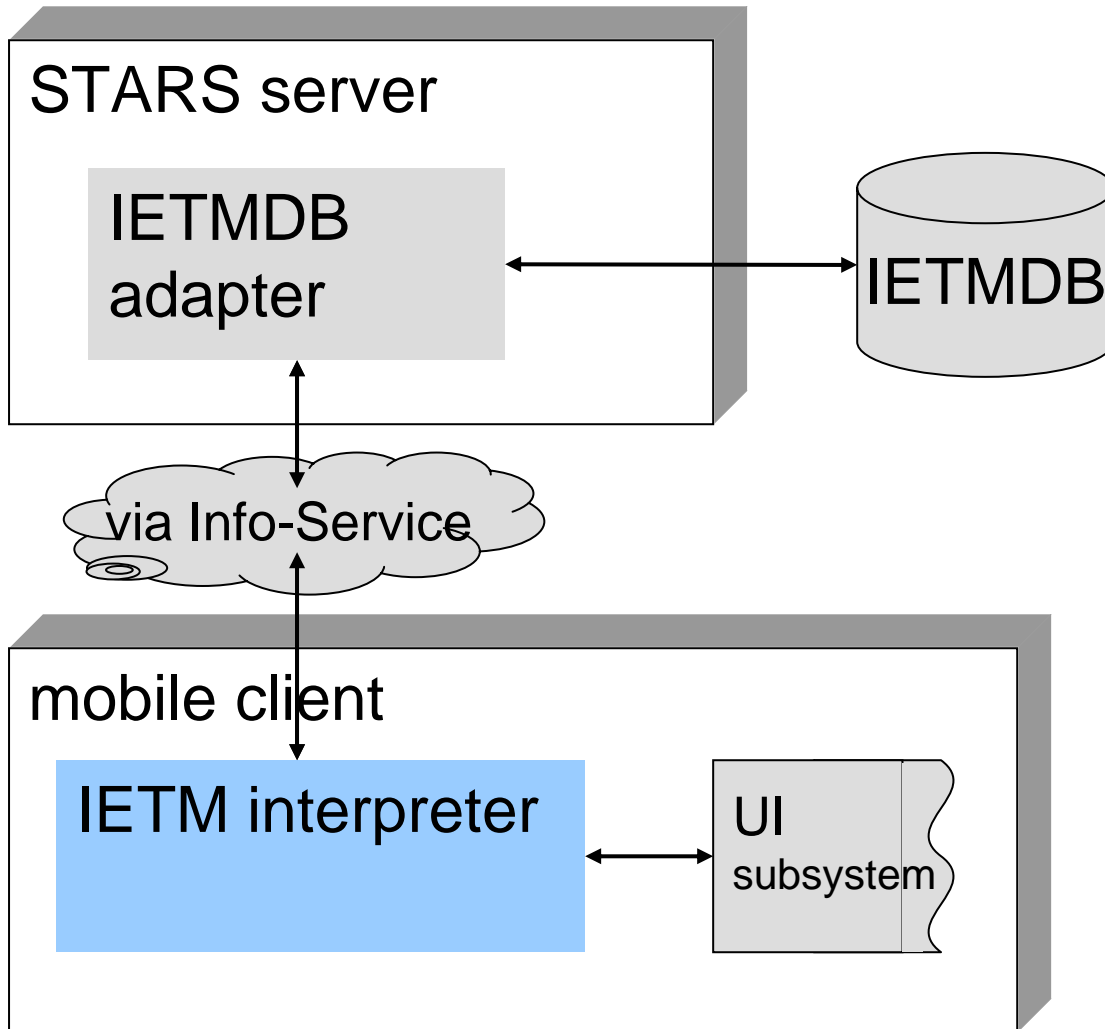

- Interpreter is separated from the database and runs on client
- Enables execution of procedure in the absence of connection

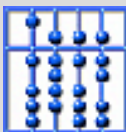

STARS Subsystems: Network

- Transparent retrieval of IETMs and supporting material (video, audio, etc.) across unreliable network connections
- Prefetching and caching

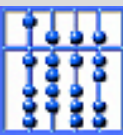
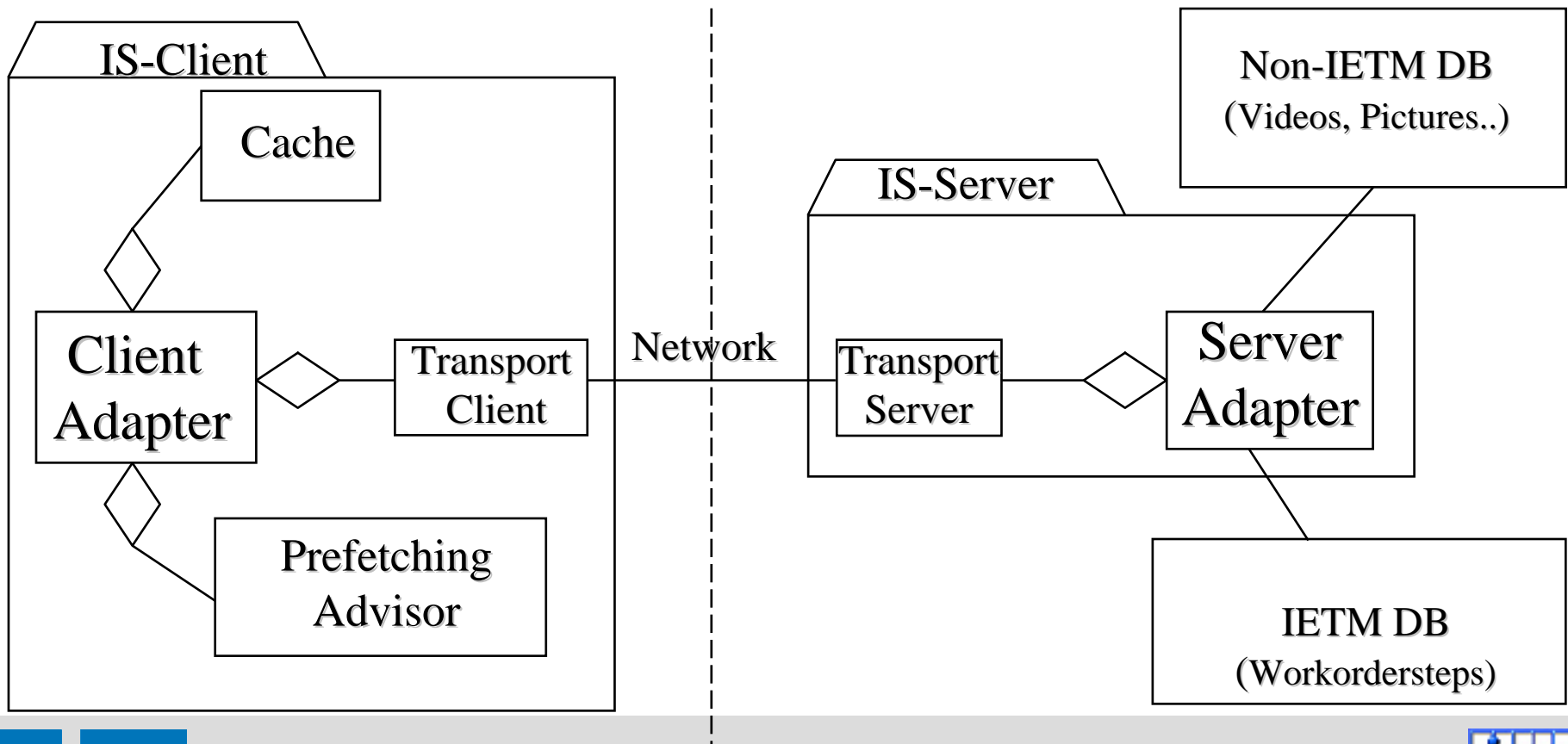

STARS Subsystems: Network

Prefetching and caching based on

- location
- work order
- statistical analysis of history

Request statistic:

- History $[d_{t1}, d_{t2}, \dots]$
- Update rules for weights:

$$w(d_{ti-1}, d_{ti}) += 2$$

$$w(d_{ti-2}, d_{ti}) += 1$$

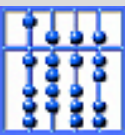
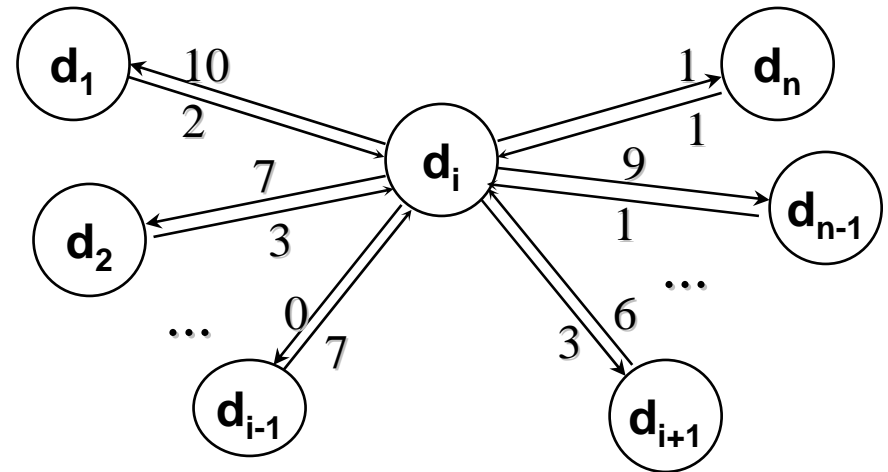

STARS Subsystems: User Interface

- Permanent maintenance support by showing single work steps and involved items
- Support through technical multimedia documents:
Texts, AR, 2D graphs, movies, images, pdf-documents
- Input modes:
Speech, recognition, keyboard input, access card, iButton
- Output modes:
HMD, LCD plate, speech synthesis

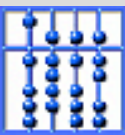

STARS Subsystems: User Interface

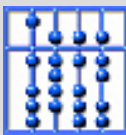
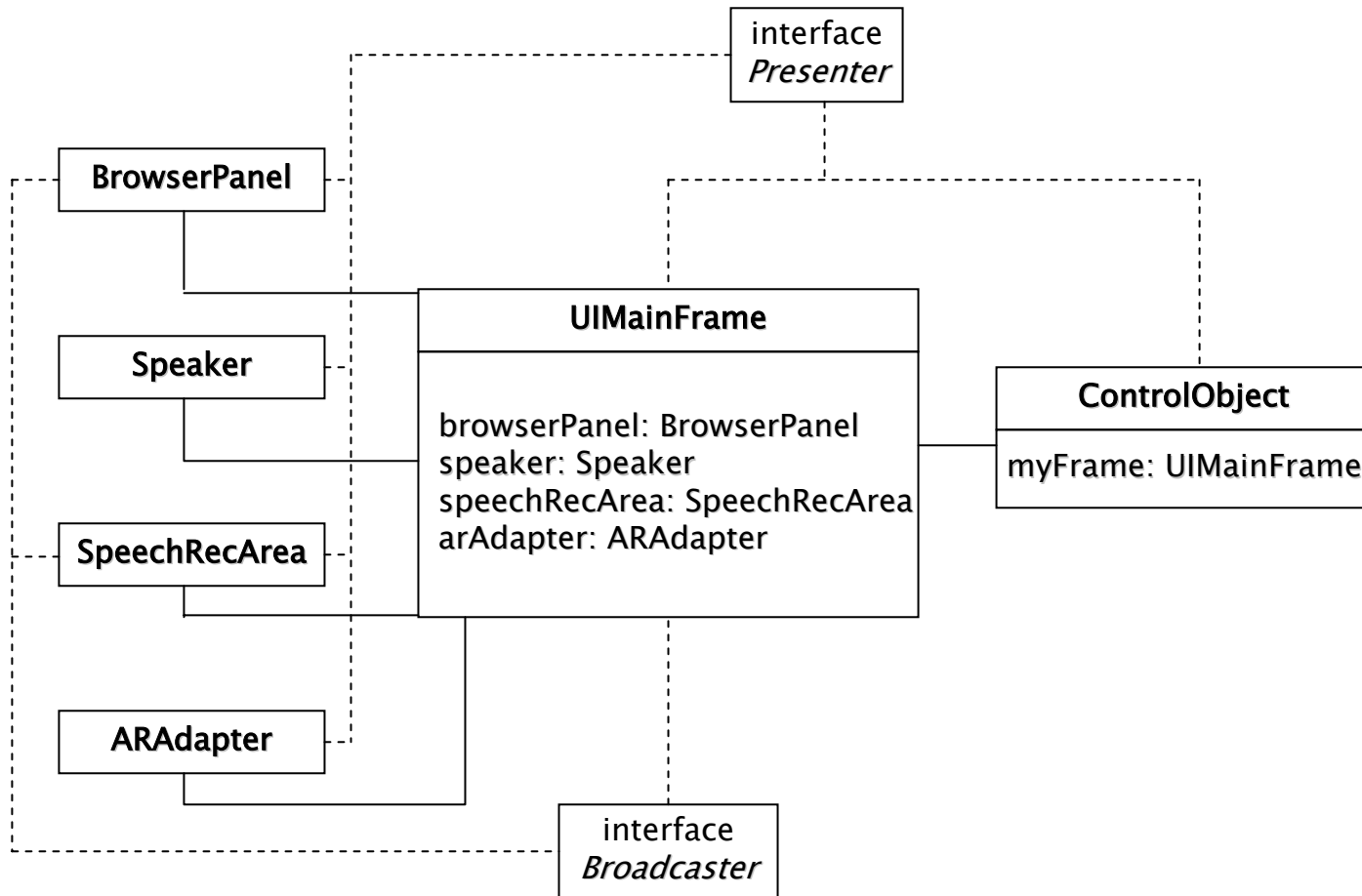

STARS Subsystems: Augmented Reality

Ingredients:

- Physical mockup
- Virtual model (OpenGL, VRML)
- 2D tracking (normalized cross-correlation)
- 3D calibration (Tsai)
- 3D rendering (OpenGL)
- Connection to user interface component (CORBA)

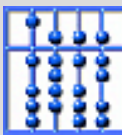
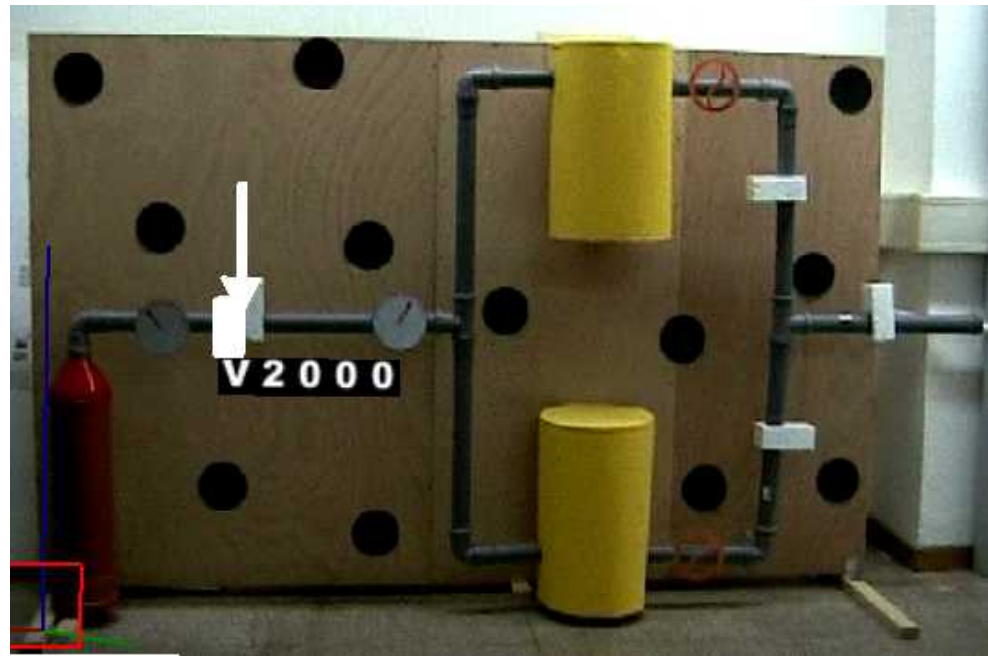
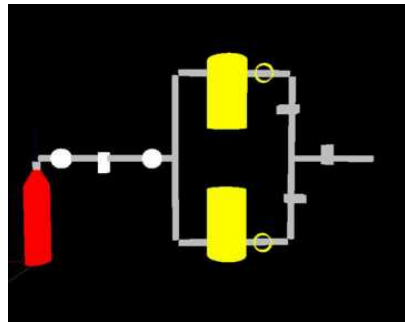

STARS Subsystems: Augmented Reality

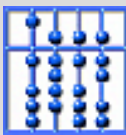
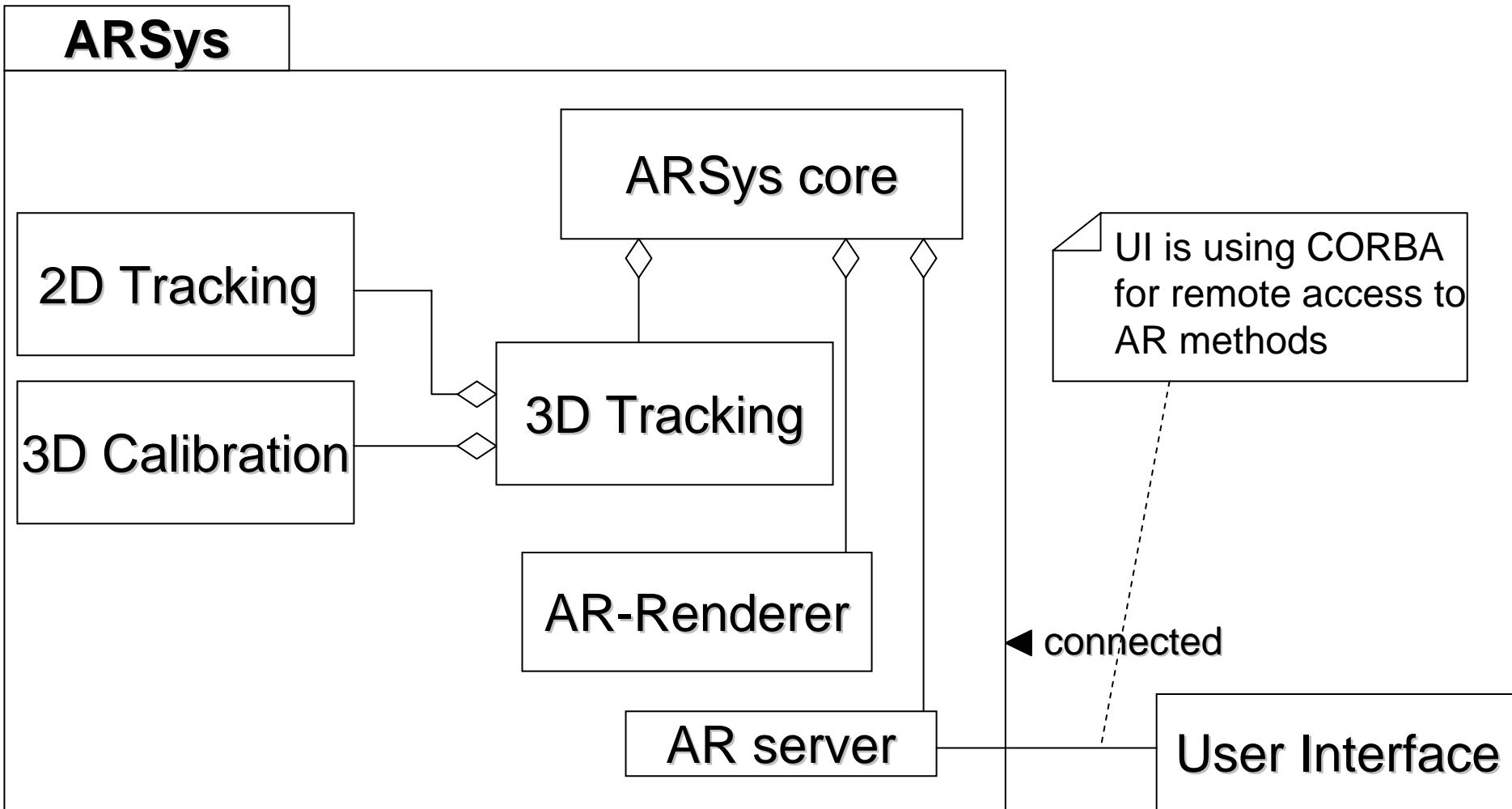

STARS Subsystems: Augmented Reality

Augmented rendering

- Connection to the user interface component:
 - Highlight object (obj, form)
 - Label object (obj, text)
 - Display information (text, screenpos): id
 - Clear information (id)
 - Set compass (object, form)
 - Is visible (obj): bool
- Geometric primitives
 - Objects with unique ids, geometric & photometric descriptions, local transformations
 - Optional labeling string + transformation
 - Transformation for arrow placement
 - Drawing style: normal (full, wireframe), highlighted, not drawn

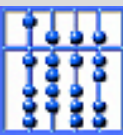

Prototype implementation focusing on

- Network
- User Interface/AR mode
- Rudimentary implementation of IETM subsystem

Two hour demo with customer (Siemens Nuclear Power):

- Helium Flushing procedure
- Simulated variety of situations and UI modes

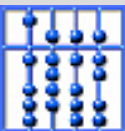

- Linking geometrical information models
 - Geometrical model is usually not present in explicit form in the legacy information
 - Manually linking geometrical models and legacy information is costly, if feasible
 - Need for AR authoring system for creating such links.
- Generic AR components
 - Current standards (VRML) defined for visualization
 - AR requires more dynamic languages, enabling the interactive manipulation of geometrical models
 - Need for domain independent interface between AR and UI

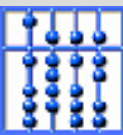

- Multi-model user interface
 - AR is only one of several user interface modes
 - An AR view needs to interact with other user interface components and views.
 - Need for a component oriented view of AR systems.
- Mobile and unreliable networks
 - AR systems are often mobile
 - Rely on wireless networks for data exchange, unreliable and low bandwidth
 - Geometrical models and related information models are usually large
 - Need for a network component for shielding the system from crashes and low bandwidth

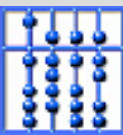

Acknowledgments

Coauthors: Oliver Creighton, Allen Dutoit, Rafael Kobylinski, Christoph Vilsmeier, Bernd Brügge

Students and coaches both at TUM and CMU

Clients: Erwin Rusitschka (Framatome ANP; ARVIKA), Dick Martin (Inmedius, CMU)

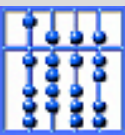

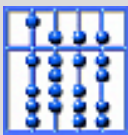

Remote Mixed Reality Excavation

- Long-distance Tele-Operation -

- Real site:
 - Video more detailed than model
 - Large time lag
- Control site:
 - Simulated operations
- Issues
 - Display centricity
 - Control-display mapping

