

# 3D Computer Vision II

## Reminder Projective Geometry, Transformations

Nassir Navab

based on a course given at UNC by Marc Pollefeys & the book "Multiple View Geometry" by Hartley & Zisserman

October 27, 2009

# 2D Transformations

## 2D Transformations

- Scaling
  - Isotropic Scaling
  - Non-isotropic Scaling
- Rotation
- Translation
- Euclidean Transformation
- Metric Transformation (Similarity)
- Affine Transformation
- Projective Transformation

## 2D Transformations – Isotropic Scaling

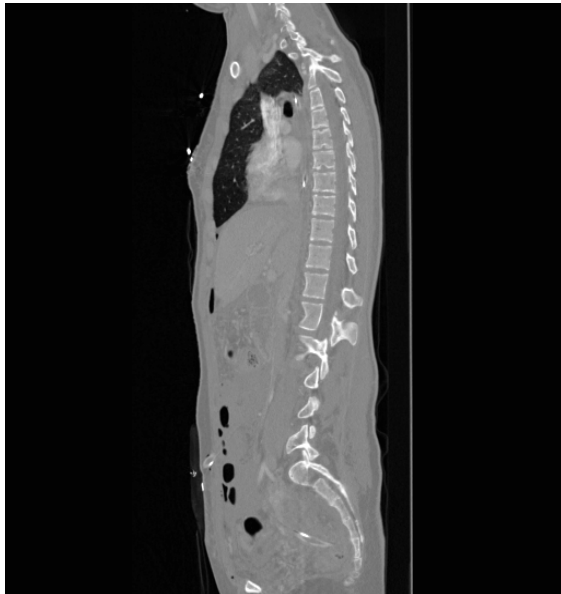

## 2D Transformations – Isotropic Scaling

- Same scaling factor in both dimensions:

$$\begin{bmatrix} x' \\ y' \end{bmatrix} = \begin{bmatrix} sx \\ sy \end{bmatrix} = \begin{bmatrix} s & 0 \\ 0 & s \end{bmatrix} \begin{bmatrix} x \\ y \end{bmatrix}$$

## 2D Transformations – Non-Isotropic Scaling

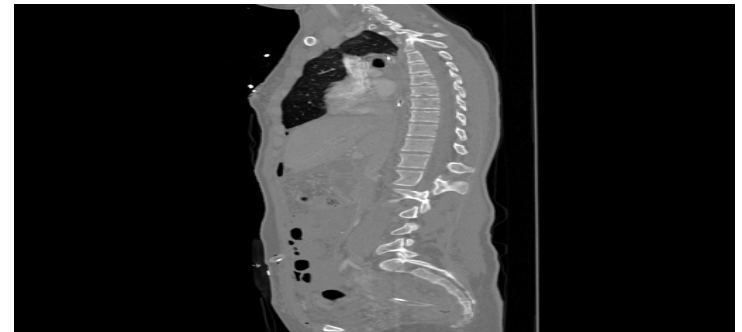

## 2D Transformations – Non-Isotropic Scaling

- Different scaling factors in the two dimensions:

$$\begin{bmatrix} x' \\ y' \end{bmatrix} = \begin{bmatrix} s_1 x \\ s_2 y \end{bmatrix} = \begin{bmatrix} s_1 & 0 \\ 0 & s_2 \end{bmatrix} \begin{bmatrix} x \\ y \end{bmatrix}$$

## 2D Transformations – Rotation

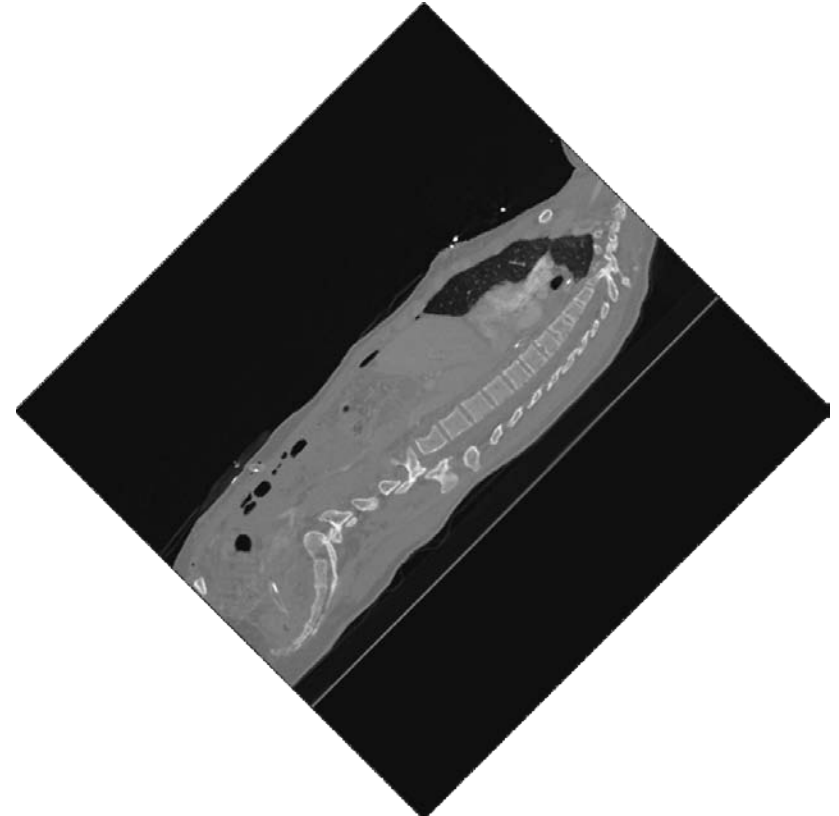
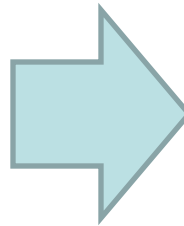
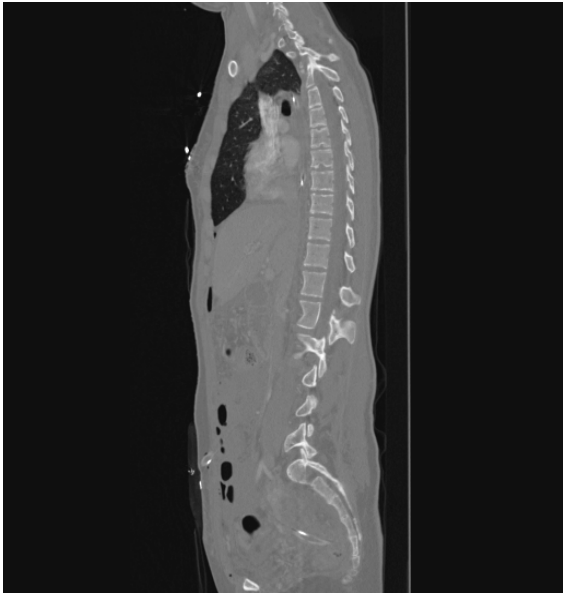



## 2D Transformations – Rotation

Rotation around origin by angle  $\theta$

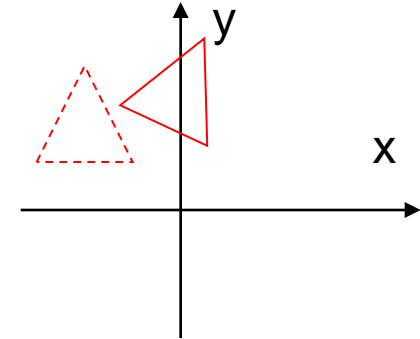

Rotation Matrix

$$R = \begin{bmatrix} \cos \theta & -\sin \theta \\ \sin \theta & \cos \theta \end{bmatrix}$$

Transformed Point

$$\vec{p}' = R\vec{p}$$

where

$$x' = x \cdot \cos \theta - y \cdot \sin \theta$$

$$y' = x \cdot \sin \theta + y \cdot \cos \theta$$

## 2D Transformations – Rotation

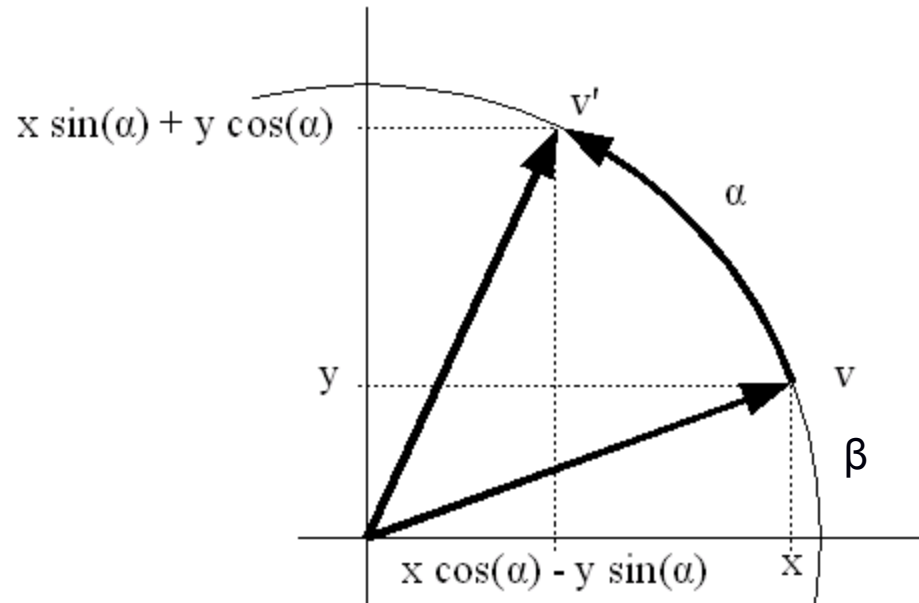

$$x' = v * \cos(\alpha + \beta) = v * \cos(\alpha) * \cos(\beta) - v * \sin(\alpha) * \sin(\beta)$$

$$x' = x \cdot \cos \alpha - y \cdot \sin \alpha$$

$$y' = v * \sin(\alpha + \beta) = v * \cos(\alpha) * \sin(\beta) + v * \sin(\alpha) * \cos(\beta)$$

$$y' = x \cdot \sin \alpha + y \cdot \cos \alpha$$

## 2D Transformations – Translation

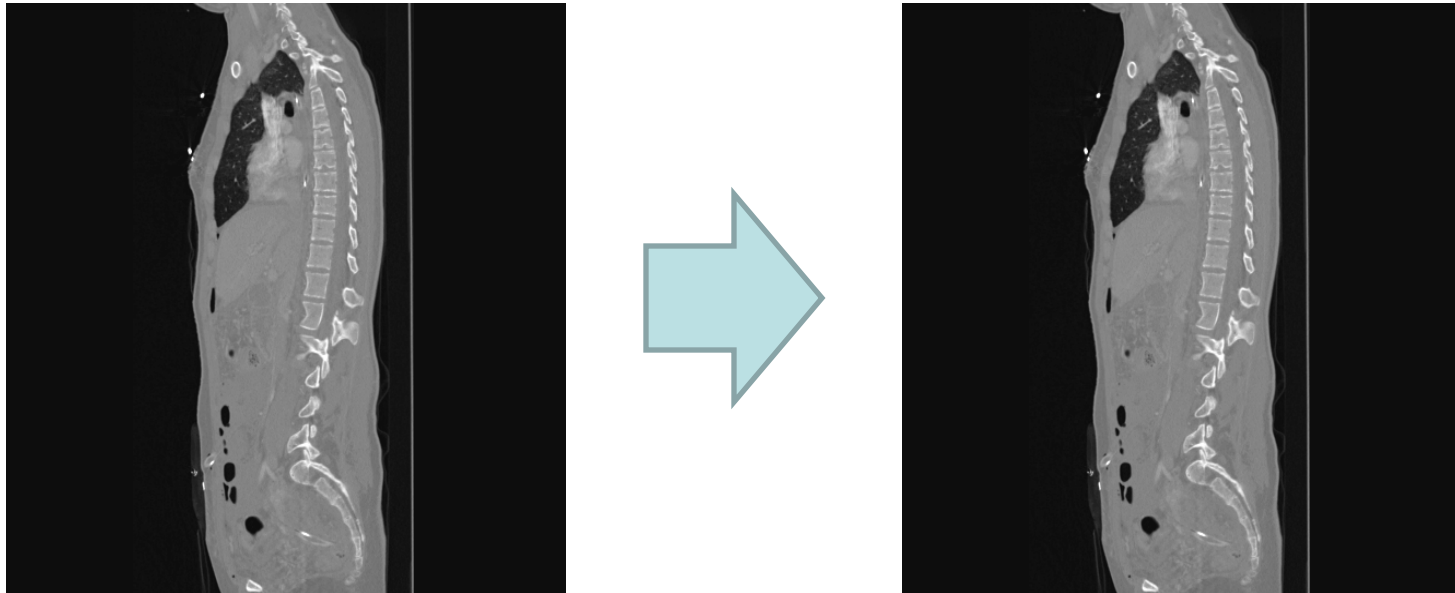

## 2D Transformations – Translation

Original point  $\vec{p} = \begin{bmatrix} x \\ y \end{bmatrix}$

Transformed point  $\vec{p}' = \begin{bmatrix} x' \\ y' \end{bmatrix}$

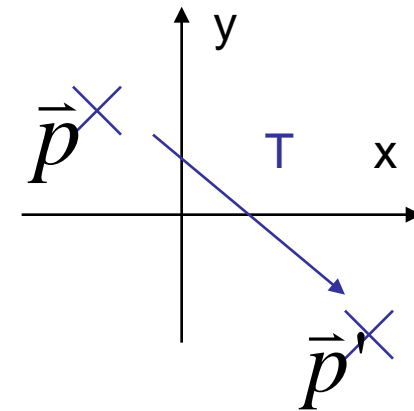

Translation Transformation  $\vec{p}' = \vec{p} + \begin{bmatrix} t_x \\ t_y \end{bmatrix}$

## 2D Transformations – Translation

- Homogeneous Coordinates:

How to get the translation transformation  $\vec{p}' = \vec{p} + \begin{bmatrix} t_x \\ t_y \end{bmatrix}$  into the *matrix-vector-product* form  $p'=Ap$  ?

Homogeneous point:  $\vec{p} = \begin{bmatrix} x \\ y \\ 1 \end{bmatrix}$

Transformation Matrix: 
$$\begin{bmatrix} 1 & 0 & t_x \\ 0 & 1 & t_y \\ 0 & 0 & 1 \end{bmatrix} \begin{bmatrix} x \\ y \\ 1 \end{bmatrix} = \begin{bmatrix} x + t_x \\ y + t_y \\ 1 \end{bmatrix}$$

# Homogeneous Coordinates of Points

Real point  $[x,y]$  (homogeneous representation):

$$\begin{bmatrix} x \\ y \\ 1 \end{bmatrix} = \lambda \begin{bmatrix} x \\ y \\ 1 \end{bmatrix} = \begin{bmatrix} \lambda x \\ \lambda y \\ \lambda \end{bmatrix}$$

## 2D Transformations – Affine Transformations

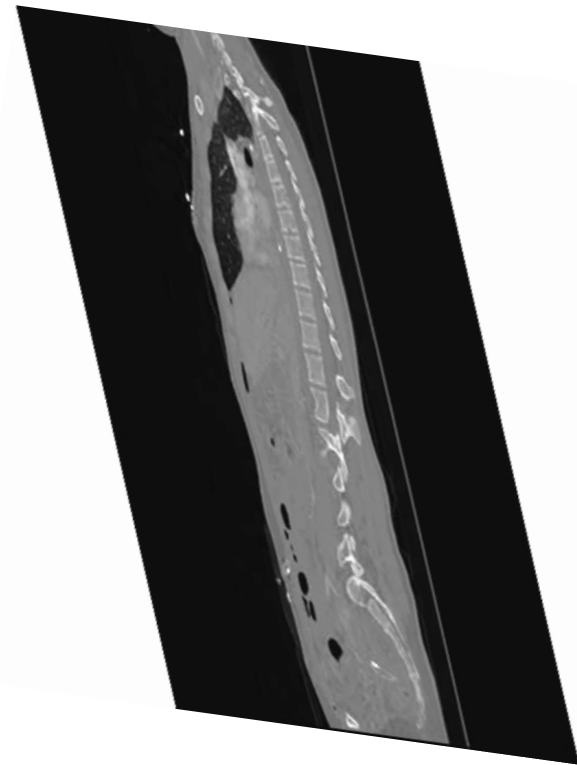
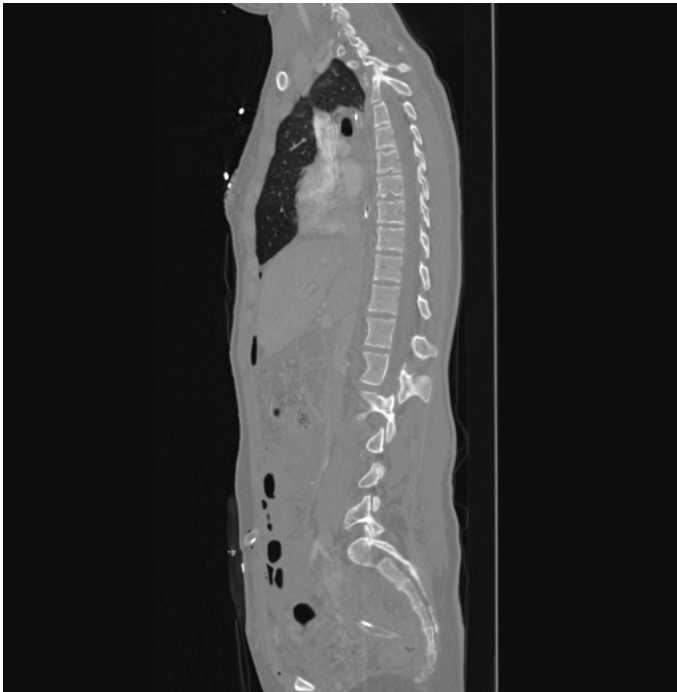

## 2D Transformations – Affine Transformations

$$\mathbf{x}' = \begin{bmatrix} ax + by \\ cx + dy \end{bmatrix} = \begin{bmatrix} a & b \\ c & d \end{bmatrix} \mathbf{x} = \mathbf{A}\mathbf{x}$$

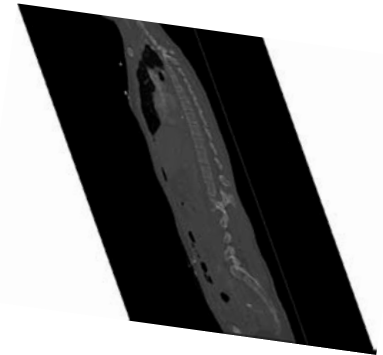
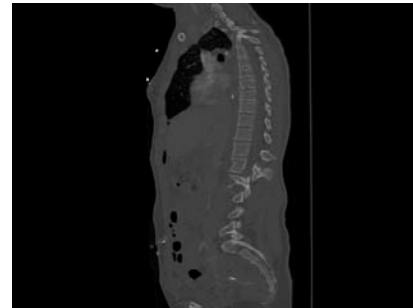

$$\mathbf{A} = \mathbf{R}(\theta) \cdot \mathbf{R}(-\phi) \cdot \mathbf{D} \cdot \mathbf{R}(\phi)$$

$$\mathbf{D} = \begin{bmatrix} \lambda_1 & 0 \\ 0 & \lambda_2 \end{bmatrix}$$

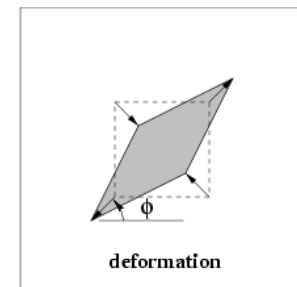
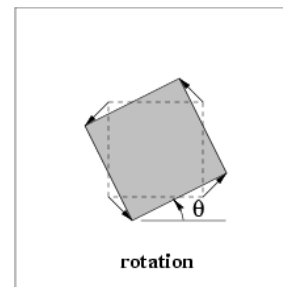



# Affine Transformations: Homogenous Coordinates

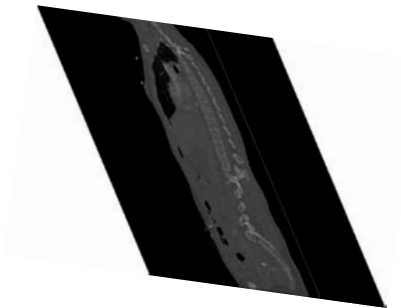
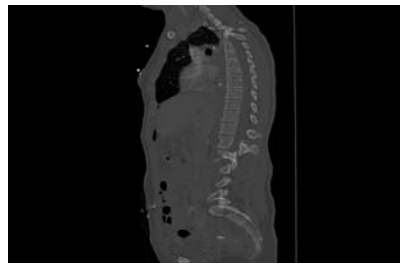

$$\mathbf{x}' = \begin{bmatrix} x' \\ y' \\ 1 \end{bmatrix} = \lambda \begin{bmatrix} ax + by \\ cx + dy \\ 1 \end{bmatrix} = \lambda \begin{bmatrix} a & b & 0 \\ c & d & 0 \\ 0 & 0 & 1 \end{bmatrix} \begin{bmatrix} x \\ y \\ 1 \end{bmatrix} = \mathbf{A}\mathbf{x}$$

# Homogeneous Coordinates of Points

- Real point  $[x,y]$  (homogeneous representation):

$$\begin{bmatrix} x \\ y \\ 1 \end{bmatrix} = \lambda \begin{bmatrix} x \\ y \\ 1 \end{bmatrix} = \begin{bmatrix} \lambda x \\ \lambda y \\ \lambda \end{bmatrix}$$

- Points at infinity:

$$\begin{bmatrix} x \\ y \\ 0 \end{bmatrix} = \lambda \begin{bmatrix} x \\ y \\ 0 \end{bmatrix}$$

- Example:

$$\begin{bmatrix} x_2 \\ y_2 \\ 1 \end{bmatrix} - \begin{bmatrix} x_1 \\ y_1 \\ 1 \end{bmatrix} \rightarrow \begin{bmatrix} x_2 - x_1 \\ y_2 - y_1 \\ 0 \end{bmatrix}$$

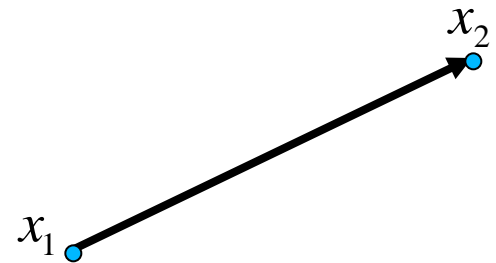

## Affine Transformations: Points at Infinity

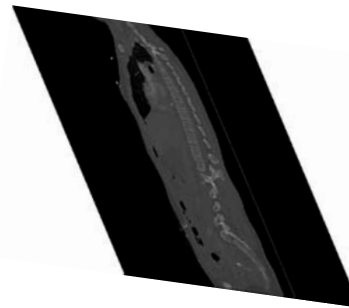
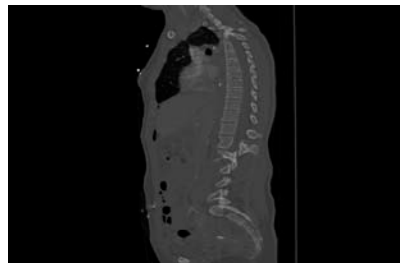

$$\mathbf{x}' = \begin{bmatrix} x' \\ y' \\ 0 \end{bmatrix} = \lambda \begin{bmatrix} a & b & 0 \\ c & d & 0 \\ 0 & 0 & 1 \end{bmatrix} \begin{bmatrix} x \\ y \\ 0 \end{bmatrix} = \lambda \begin{bmatrix} ax + by \\ cx + dy \\ 0 \end{bmatrix}$$

## General Affine Transformations (6 Parameters)

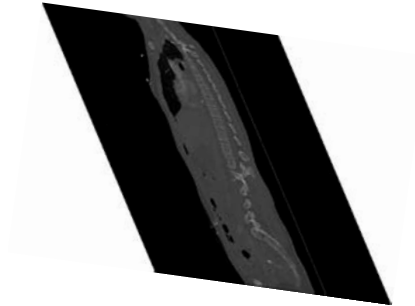
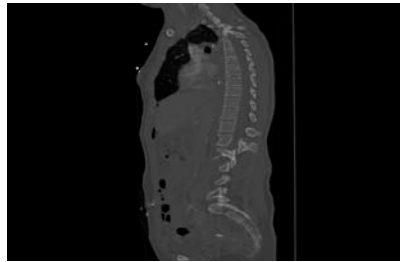

$$\mathbf{x}' = \begin{bmatrix} x' \\ y' \\ 1 \end{bmatrix} = \lambda \begin{bmatrix} ax + by + c \\ dx + ey + f \\ 1 \end{bmatrix} = \lambda \begin{bmatrix} a & b & c \\ d & e & f \\ 0 & 0 & 1 \end{bmatrix} \begin{bmatrix} x \\ y \\ 1 \end{bmatrix} = \mathbf{A}\mathbf{x}$$

## 2D Transformations – Projective Transformations

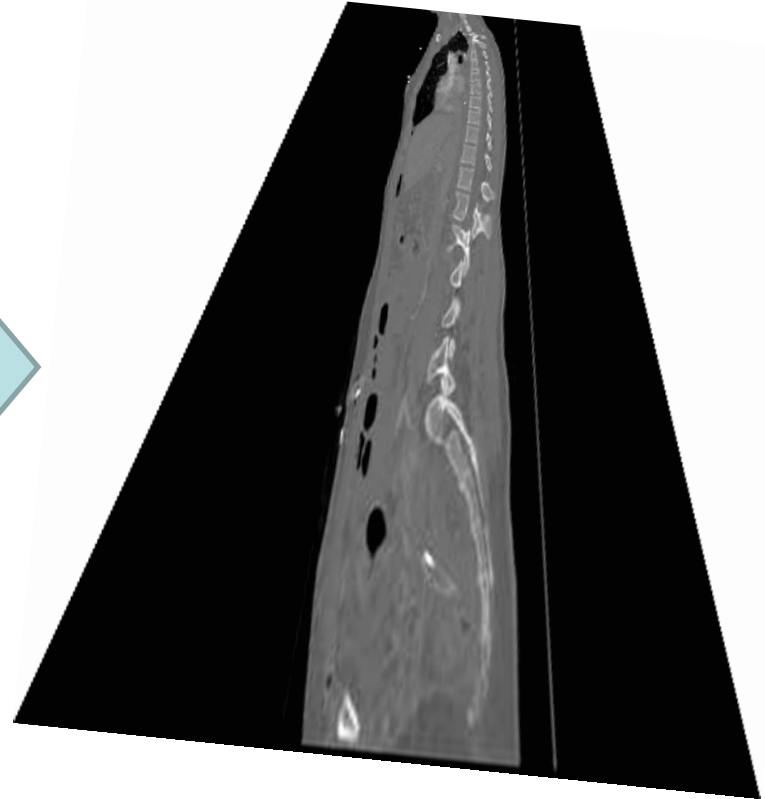
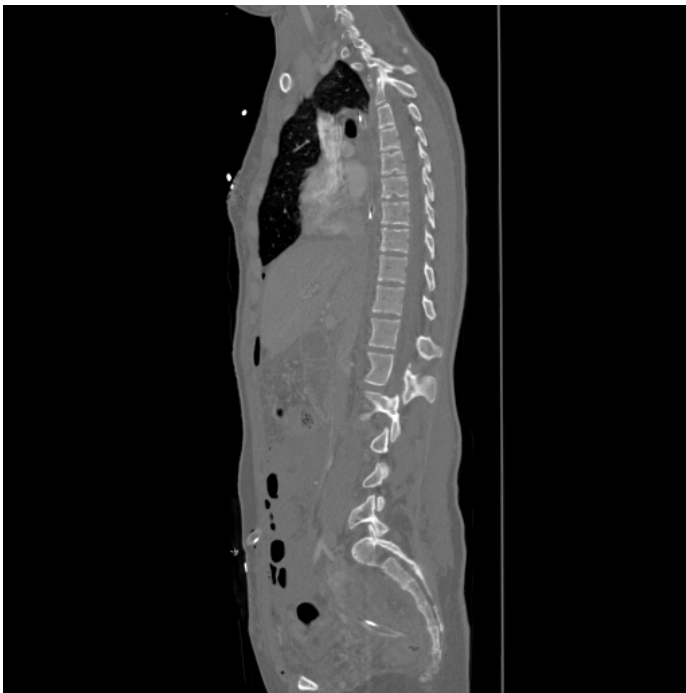

## 2D Transformations – Projective Transformations

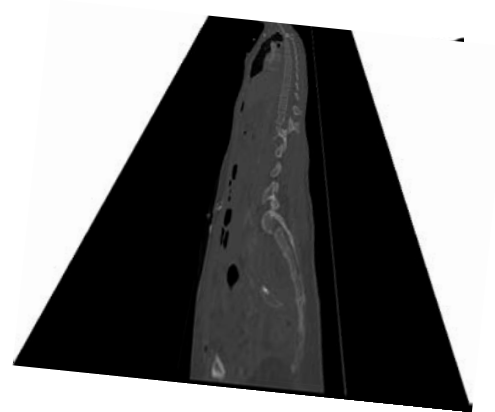
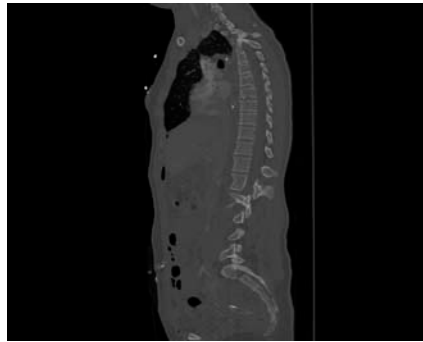

$$\mathbf{x}' = \begin{bmatrix} x' \\ y' \\ 1 \end{bmatrix} = \lambda \begin{bmatrix} ax + by + c \\ dx + ey + f \\ gx + hy + 1 \end{bmatrix} = \lambda \begin{bmatrix} a & b & c \\ d & e & f \\ g & h & 1 \end{bmatrix} \begin{bmatrix} x \\ y \\ 1 \end{bmatrix} = \mathbf{H}\mathbf{x}$$

## 2D Transformations – Projective Transformations

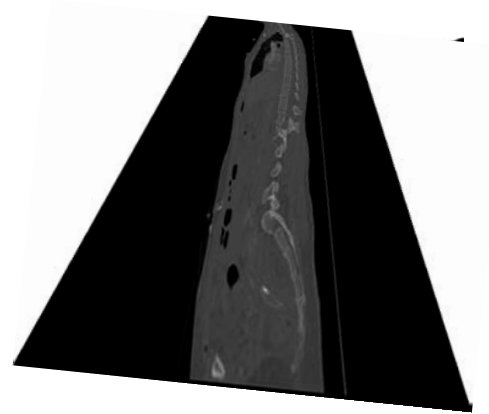
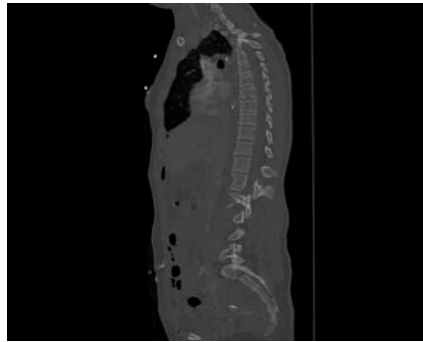

$$\mathbf{x}' = \begin{bmatrix} x' \\ y' \\ 1 \end{bmatrix} = \lambda \begin{bmatrix} ax + by + c \\ dx + ey + f \\ gx + hy + 1 \end{bmatrix} \rightarrow \begin{cases} x' = \frac{ax + by + c}{gx + hy + 1} \\ y' = \frac{dx + ey + f}{gx + hy + 1} \end{cases}$$

## Affine Transformations: Points at Infinity

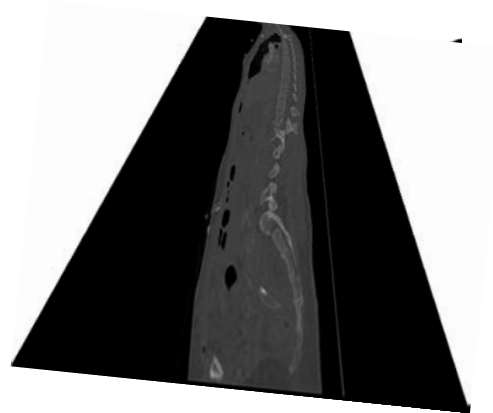
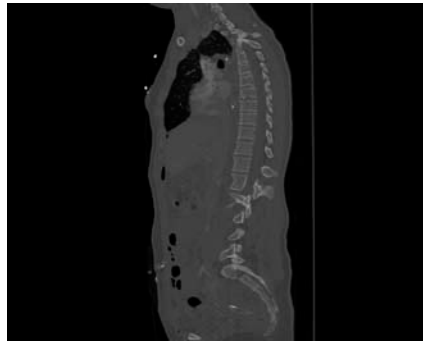

$$\mathbf{x}' = \begin{bmatrix} x' \\ y' \\ 1 \end{bmatrix} = \lambda \begin{bmatrix} a & b & c \\ d & e & f \\ g & h & 1 \end{bmatrix} \begin{bmatrix} x \\ y \\ 0 \end{bmatrix} = \lambda \begin{bmatrix} ax + by \\ dx + ey \\ gx + hy \end{bmatrix}$$



## 2D Transformations – Projective Transformations

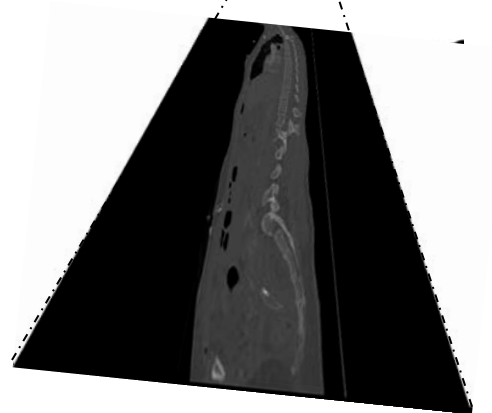
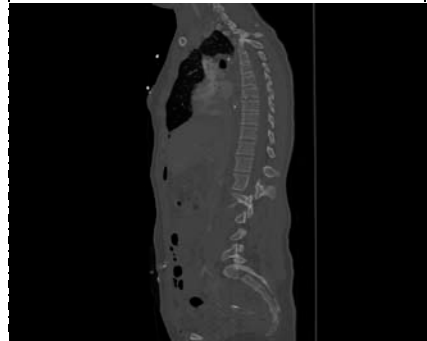

$$\mathbf{x}' = \begin{bmatrix} x' \\ y' \\ 1 \end{bmatrix} = \mathbf{H} \begin{bmatrix} x \\ y \\ 0 \end{bmatrix} = \lambda \begin{bmatrix} ax + by \\ dx + ey \\ gx + hy \end{bmatrix} \rightarrow \begin{cases} x' = \frac{ax + by}{gx + hy} \\ y' = \frac{dx + ey}{gx + hy} \end{cases}$$

## 2D Projective Space – The Projective Plane

- A line in plane can be represented as:  $ax+by+c=0$
- We can represent any line  $l$  by three parameters  $a$ ,  $b$ , and  $c$
- The same line  $l$  can be represented by multiples of  $a$ ,  $b$  and  $c$  ( $ka$ ,  $kb$  and  $kc$  for a scalar  $k$ ) since:  $kax+kby+kc=k*0=0=ax+by+c$
- A line is represented by a set of vectors, which differ only in scale  $k$  ( $k$  non zero)
- This equivalence set of vectors is known as a **Homogeneous Vector**
- Any particular vector of the class is a representative of the equivalence class
- The set of all these equivalence classes (i.e. homogeneous vectors) of vectors in  $\mathbb{R}^3$  (excluding  $(0,0,0)$ ) is called the **Projective Space  $P^2$**

# A Model for the Projective Plane

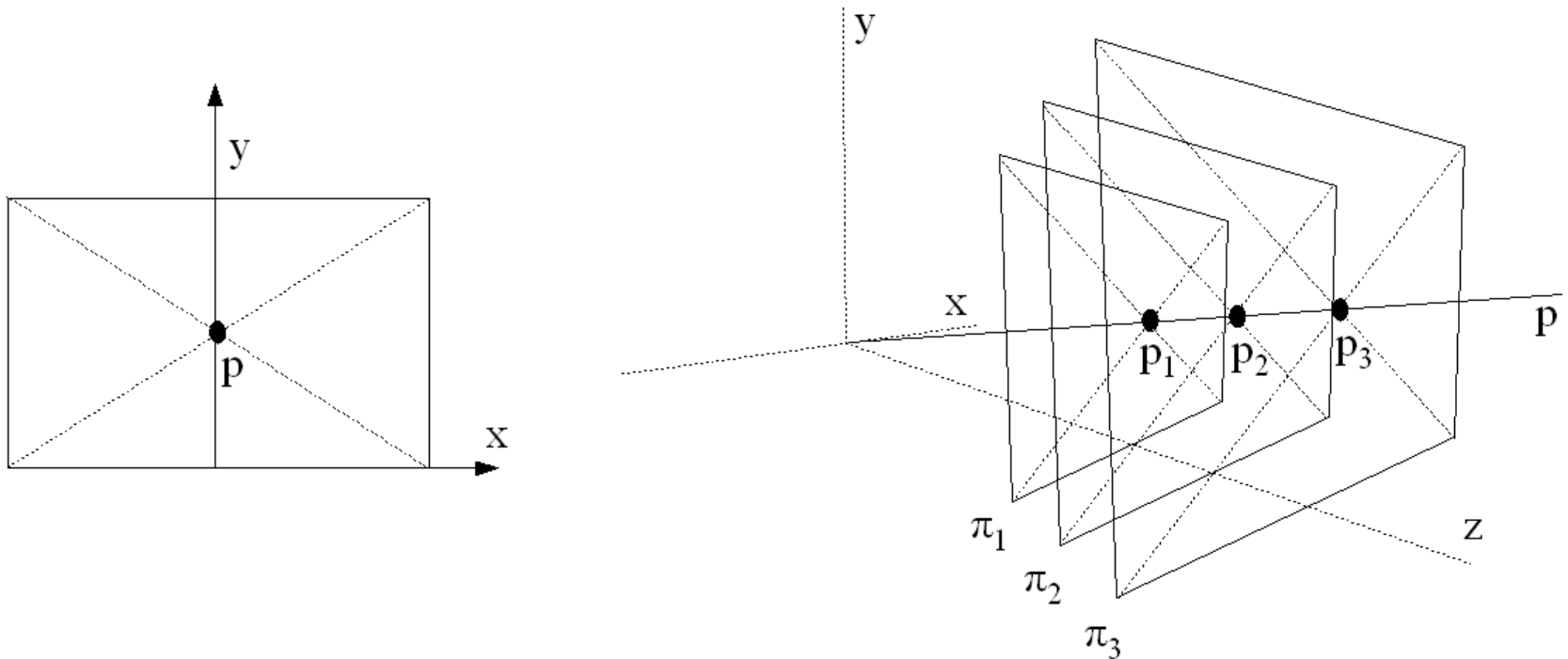

We'll use this intuition throughout the course.

# A Model for the Projective Plane

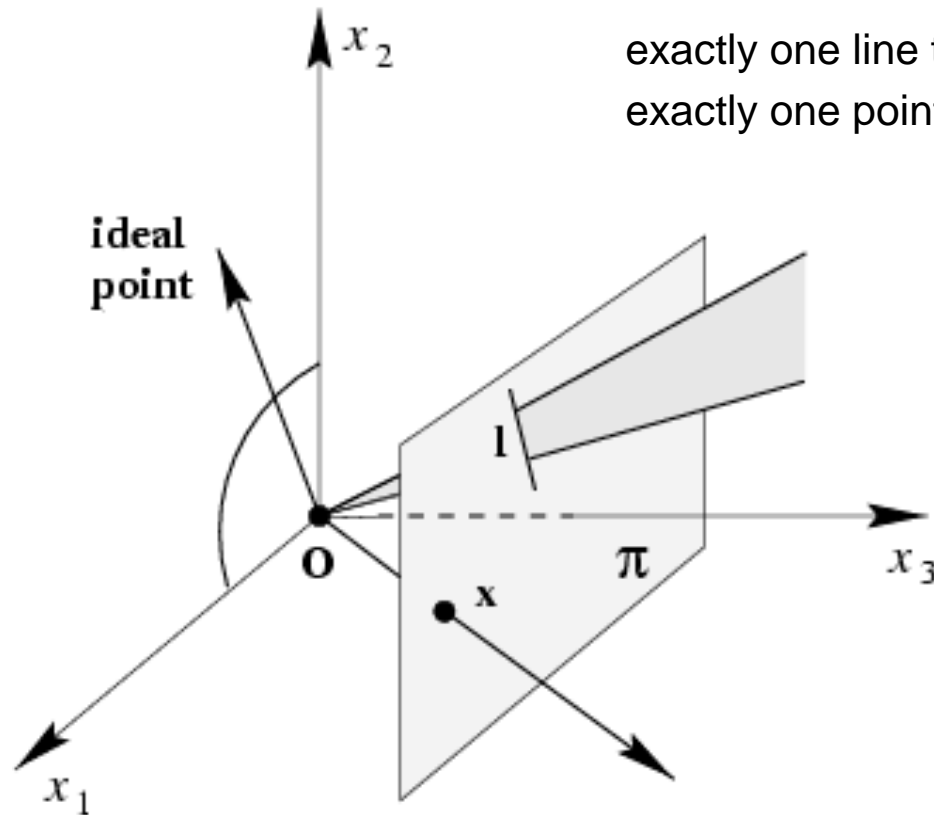

exactly one line through two points

exactly one point at intersection of two lines

# Homogeneous Coordinates – Points

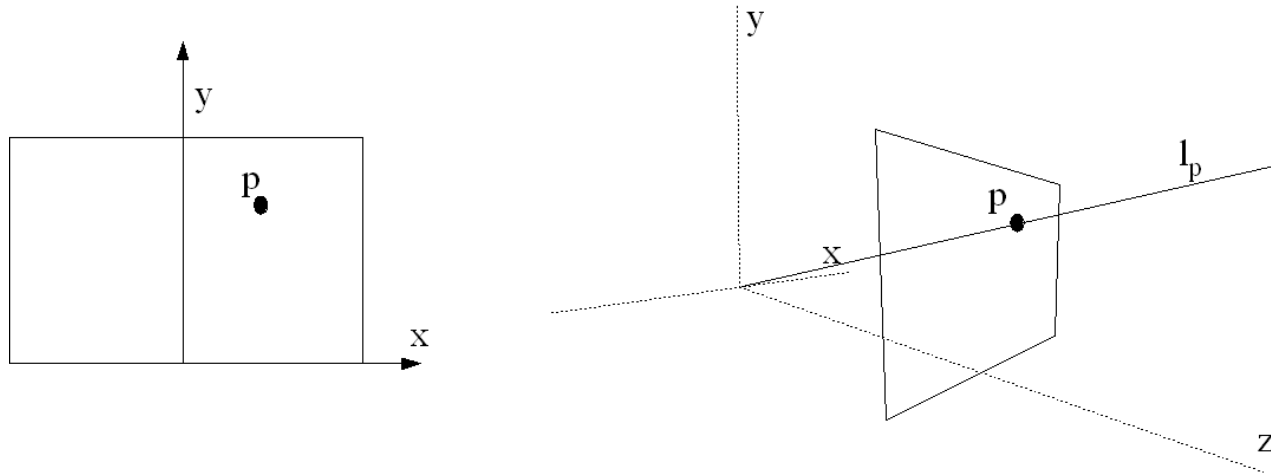

$$p = (x, y, 1)^T \sim k(x, y, 1)^T, \forall k \neq 0$$

- A point is represented in  $P^2$  by a simple vector
- Remember that every vector in  $P^2$  is just a representative of an equivalence class of vectors
- Hence a point is represented by any vector of the equivalence class

## Homogeneous Coordinates – Lines

- In  $P^2$  lines as well are represented as vectors
- Because of the equivalence class of vectors, any vector of the class is representative

$$ax + by + c = 0 \quad (a, b, c)^T$$

$$(ka)x + (kb)y + kc = 0, \forall k \neq 0$$

$$(a, b, c)^T \sim k(a, b, c)^T$$

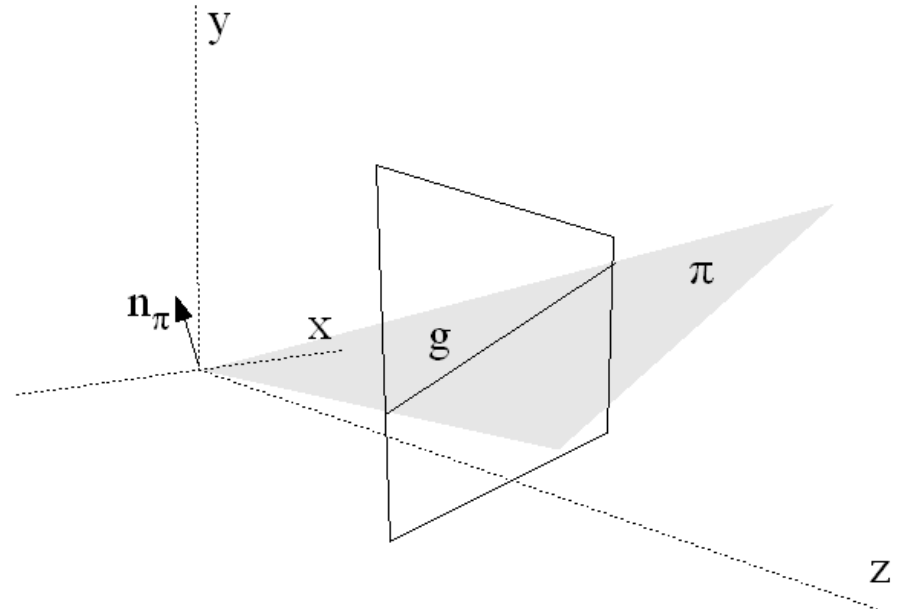

Note that Points and Lines are represented both in  $P^2$  as vectors

## Degrees of Freedom (DOF)

- DOF refers to the number of parameters needed to specify an object in the respective space
- Examples:

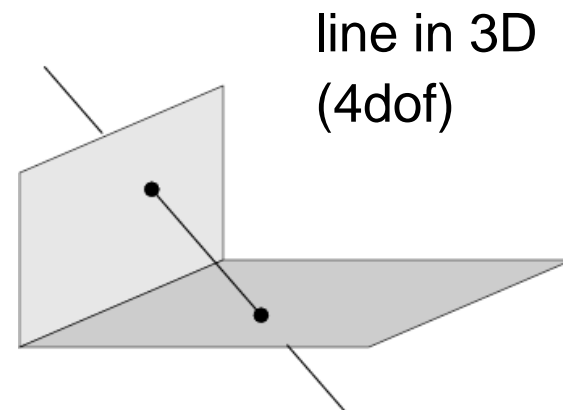
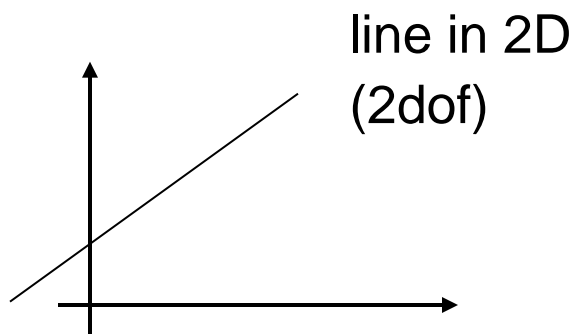

## Homogeneous Vectors (in $P^2$ ) have 2 DOF

Any homogeneous vector  $x$  (in  $P^2$ ) has 3 coordinates but only 2 DOF since it is up to scale – hence only the two ratios  $x_1:x_3$  and  $x_2:x_3$  between the coordinates are significant.

Homogeneous vector  $x$ :  $(x_1, x_2, x_3)^T = k \cdot (x_1, x_2, x_3)^T$

The ratios  $x_1:x_3$  and  $x_2:x_3$ :

$$x_1 : x_3 = \frac{x_1}{x_3} = \frac{kx_1}{kx_3} \quad x_2 : x_3 = \frac{x_2}{x_3} = \frac{kx_2}{kx_3}$$



## Incidence of Points and Lines

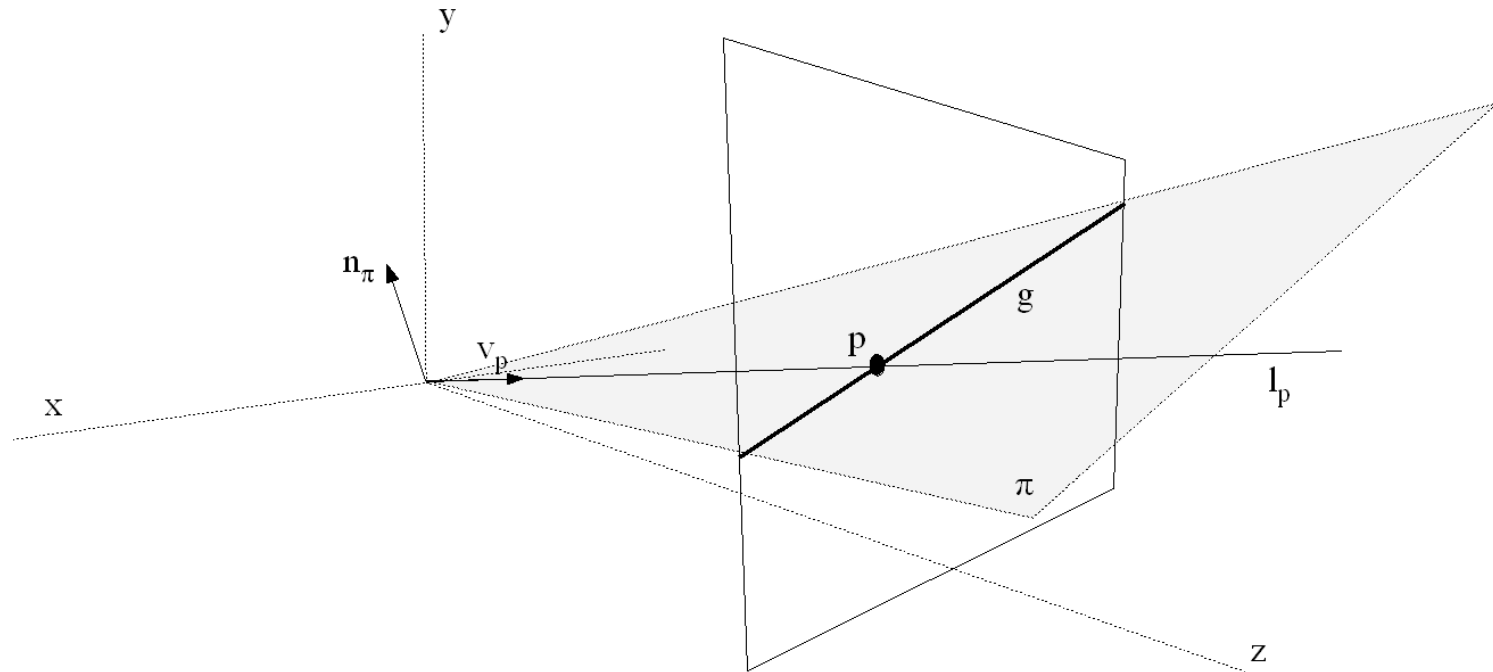

The point  $x$  lies on the line  $l$  if and only if  $x^T l = l^T x = 0$

$x = (x, y, 1)^T$  on  $l = (a, b, c)^T$  if and only if  $ax + by + c = 0$

$$(x, y, 1)(a, b, c)^T = x^T l = 0$$

## Points from Lines - Intersections of Lines

The intersection point  $\mathbf{x}$  of two lines  $\mathbf{l}_1$  and  $\mathbf{l}_2$  satisfies:

$$\mathbf{x}^t \mathbf{l}_1 = \mathbf{x}^t \mathbf{l}_2 = 0 \quad \rightarrow \quad \mathbf{x} = \mathbf{l}_1 \times \mathbf{l}_2$$

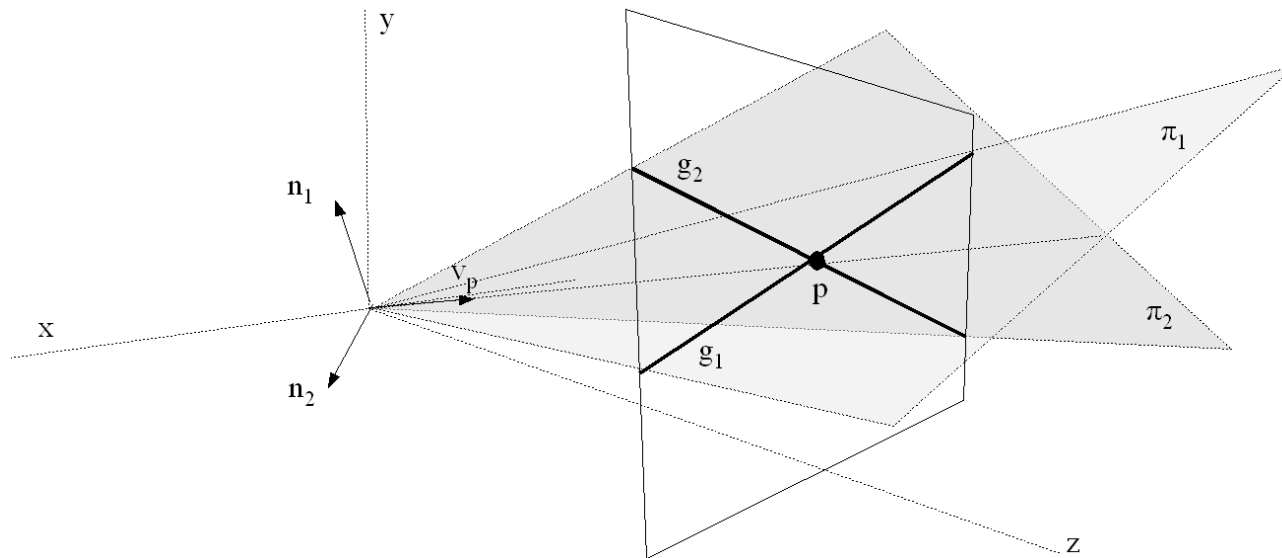

Example

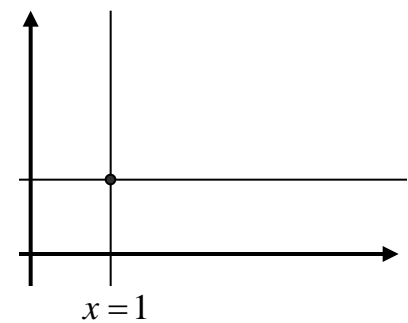

## Points from Lines - Intersections of Lines

The intersection point  $\mathbf{x}$  of two lines  $\mathbf{l}_1$  and  $\mathbf{l}_2$  satisfies:

$$\mathbf{x}^t \mathbf{l}_1 = \mathbf{x}^t \mathbf{l}_2 = 0 \quad \rightarrow \quad \mathbf{x} = \mathbf{l}_1 \times \mathbf{l}_2$$

Example

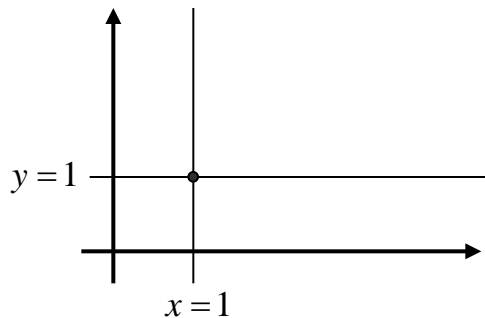

$$\begin{bmatrix} 0 \\ 1 \\ -1 \end{bmatrix} \times \begin{bmatrix} 1 \\ 0 \\ -1 \end{bmatrix} = \begin{bmatrix} -1 \\ -1 \\ -1 \end{bmatrix} \approx \begin{bmatrix} 1 \\ 1 \\ 1 \end{bmatrix}$$

## Alternative Notation for the Cross Product

The cross product of two vectors  $\mathbf{a}$  and  $\mathbf{b}$  ( $\mathbf{a} \times \mathbf{b}$ ) can be written as a product of an anti-symmetric matrix  $[\mathbf{a}]_x$  and the vector  $\mathbf{b}$

$$\mathbf{a} \times \mathbf{b} = [\mathbf{a}]_x \mathbf{b} = -[\mathbf{b}]_x \mathbf{a}$$

The appropriate anti-symmetric matrix  $[\mathbf{a}]_x$  is:

$$[\mathbf{a}]_x = \begin{bmatrix} 0 & -a_3 & a_2 \\ a_3 & 0 & -a_1 \\ -a_2 & a_1 & 0 \end{bmatrix}$$

## Points from Lines – Intersections of Lines

The intersection of two lines  $l$  and  $l'$  is the point  $x = l \times l' = [l]_x l' = -[l']_x l$

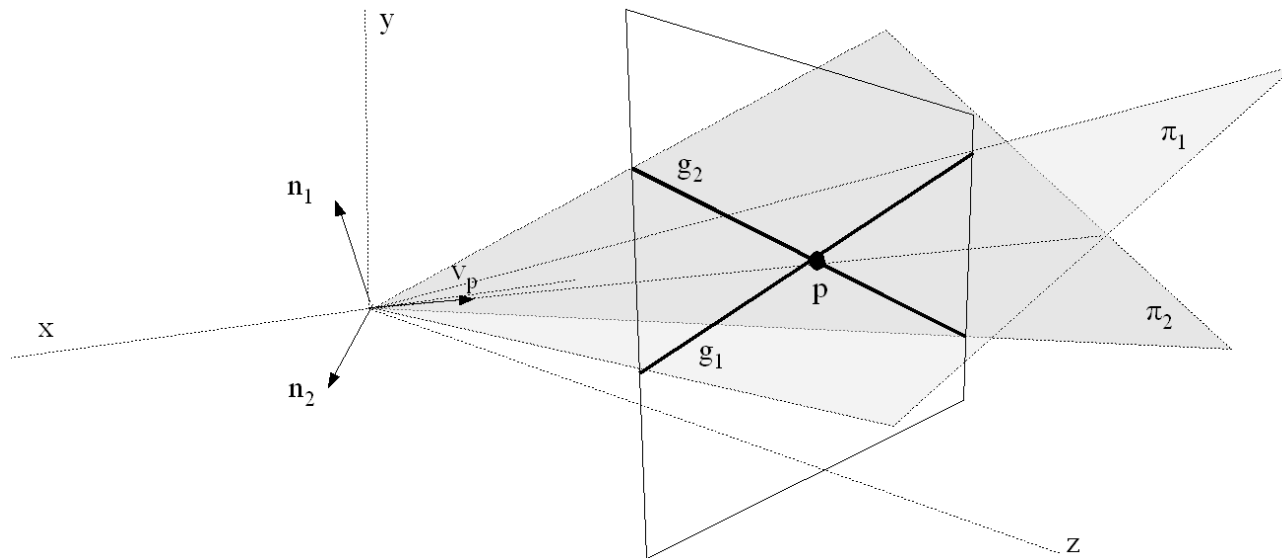

Example

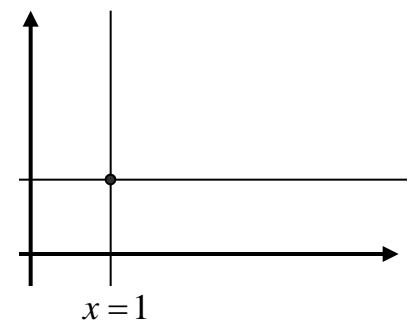

## Lines from Points – Line Joining two Points

The line  $l$  joining two points  $\mathbf{x}_1$  and  $\mathbf{x}_2$  satisfies:

$$\mathbf{x}_1^t \mathbf{l} = \mathbf{x}_2^t \mathbf{l} = 0 \quad \rightarrow \quad \mathbf{l} = \mathbf{x}_1 \times \mathbf{x}_2$$

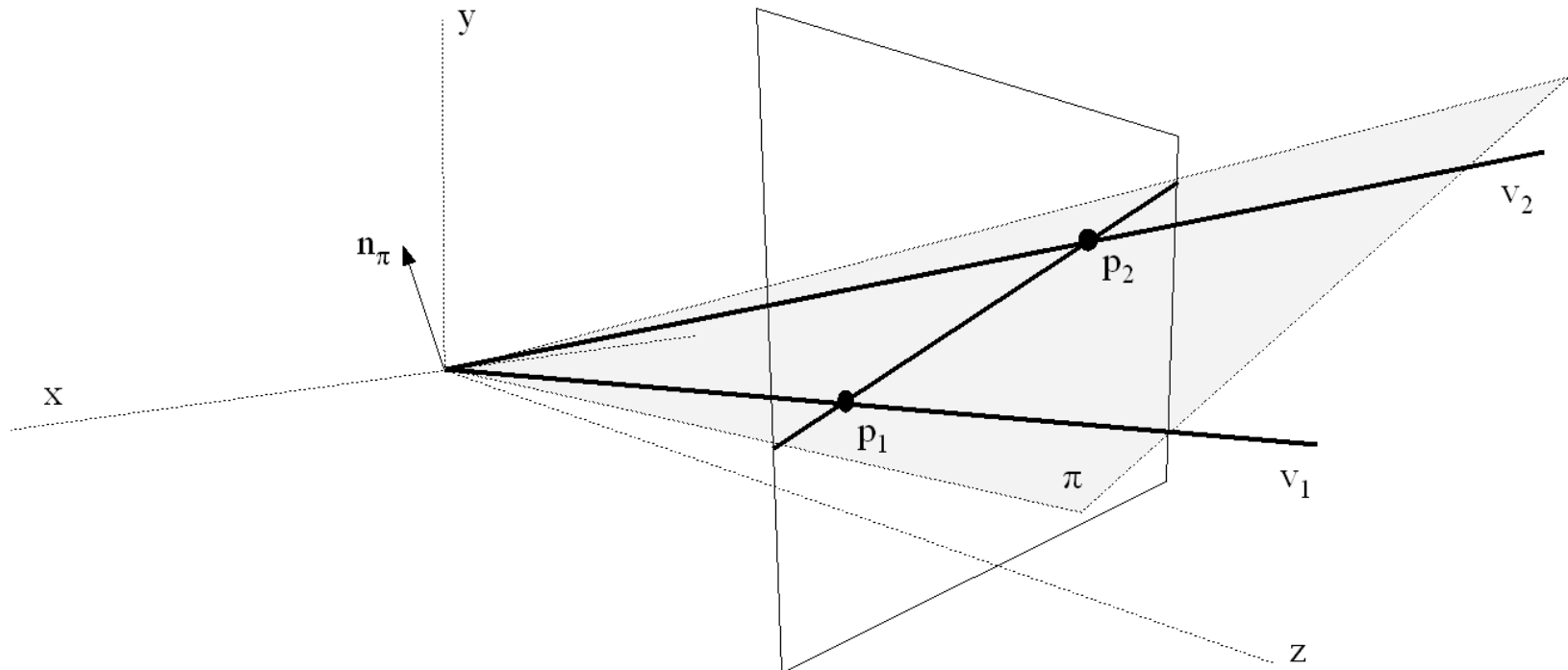

## Lines from Points – Line Joining two Points

The line through two points  $x$  and  $x'$  is the line  $l = x \times x' = [x]_x x' = -[x']_x x$

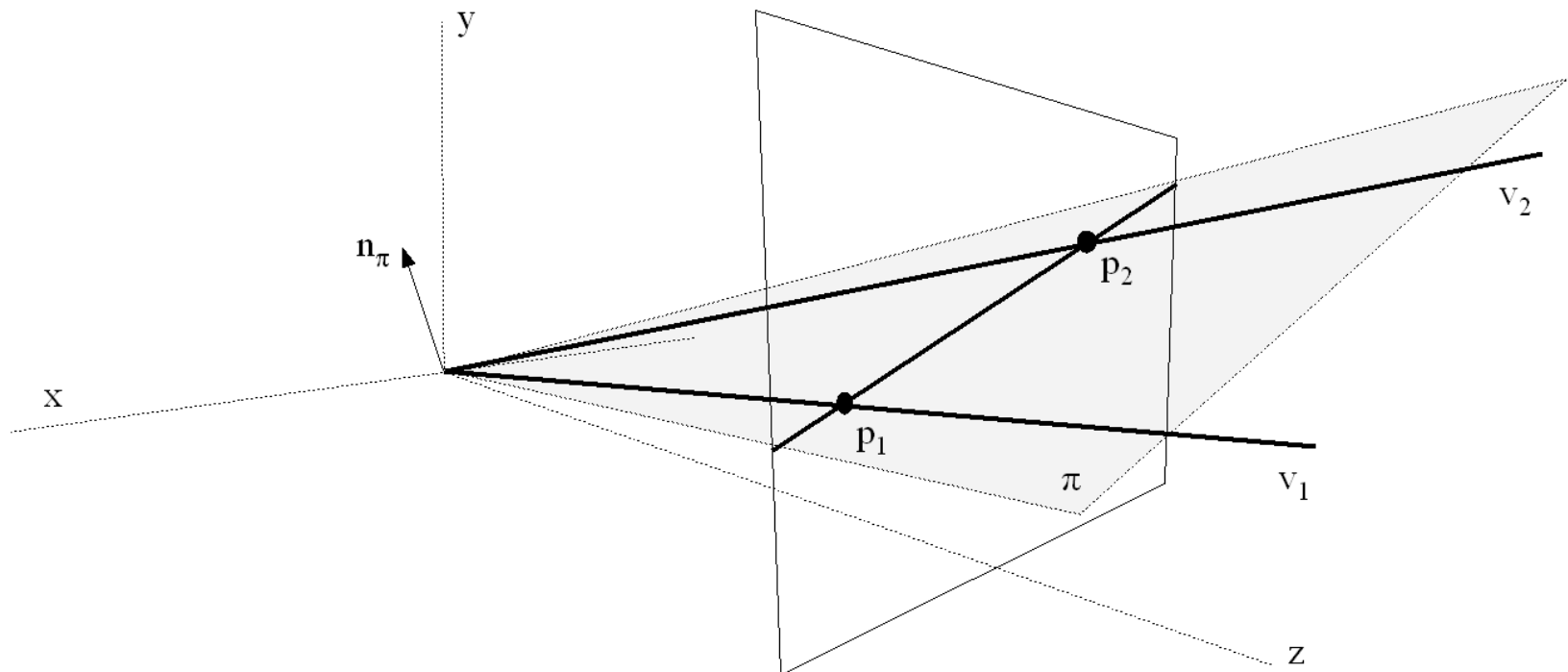

## Lines from Points – Line Joining two Points

The line through two points  $x$  and  $x'$  is the line  $l = x \times x' = [x]_x \times x' = -[x']_x \times x$

### Example

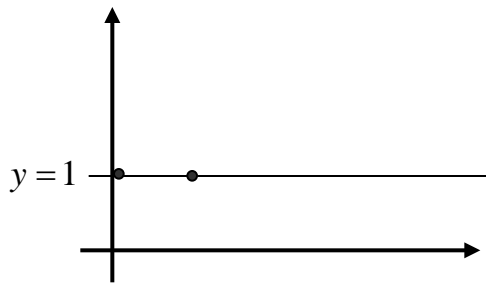

$$\begin{bmatrix} 0 \\ 1 \\ 1 \end{bmatrix} \times \begin{bmatrix} 1 \\ 1 \\ 1 \end{bmatrix} = \begin{bmatrix} 0 \\ 1 \\ -1 \end{bmatrix}$$



## Ideal Points and the Line at Infinity

Intersections of parallel lines are the points at infinity (ideal points)

$$l = (a, b, c)^T \text{ and } l' = (a, b, c')^T \quad l \times l' = (b, -a, 0)^T$$

$$[l]_x l' = \begin{bmatrix} 0 & -c & b \\ c & 0 & -a \\ -b & a & 0 \end{bmatrix} \begin{bmatrix} a \\ b \\ c' \end{bmatrix} = \begin{bmatrix} b(c'-c) \\ a(c-c') \\ 0 \end{bmatrix} \approx \begin{bmatrix} b \\ -a \\ 0 \end{bmatrix}$$

Ideal points  $(x_1, x_2, 0)^T$

Line at infinity  $l_\infty = (0, 0, 1)^T$

alternative definition of  $\mathbf{P}^2$ :  $\mathbf{P}^2 = \mathbf{R}^2 \cup l_\infty$

Note that in  $\mathbf{P}^2$  there is no distinction between ideal points and others

# Ideal Points and the Line at Infinity – an Example

Example

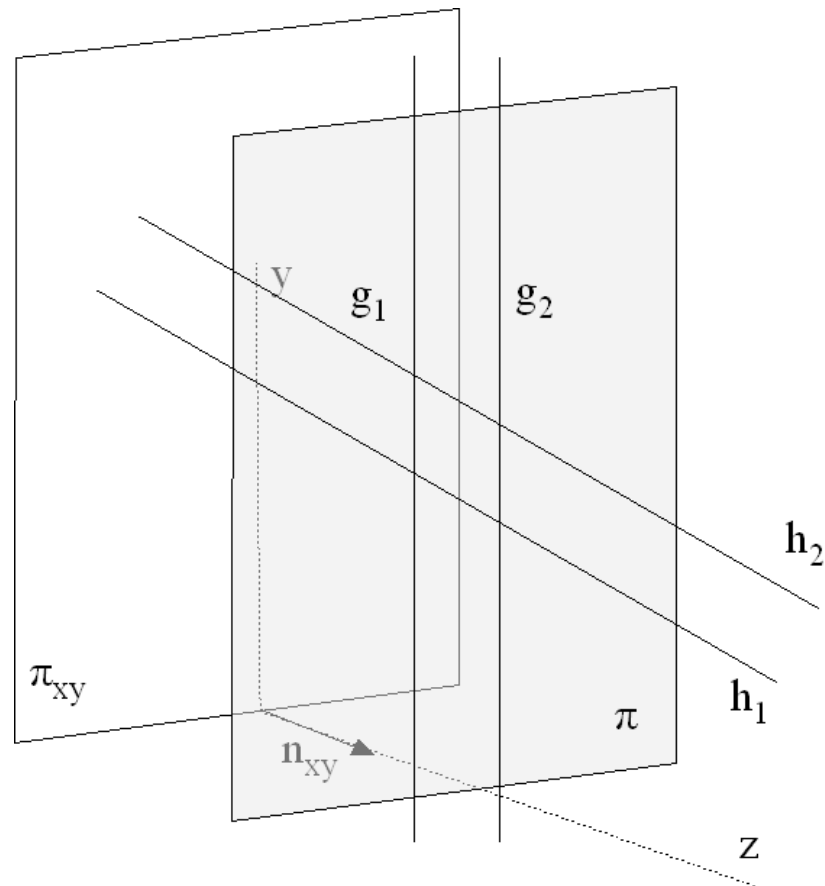
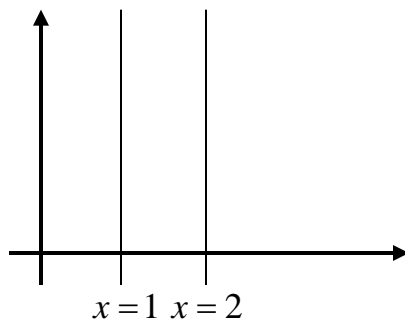

# Duality

$$\begin{array}{ccc} \mathbf{x} & \longleftrightarrow & \mathbf{l} \\ \mathbf{x}^T \mathbf{l} = 0 & \longleftrightarrow & \mathbf{l}^T \mathbf{x} = 0 \\ \mathbf{x} = \mathbf{l} \times \mathbf{l}' & \longleftrightarrow & \mathbf{l} = \mathbf{x} \times \mathbf{x}' \end{array}$$

## Duality principle:

To any theorem of 2-dimensional projective geometry there corresponds a dual theorem, which may be derived by interchanging the role of points and lines in the original theorem.

# Summary

- Projective Space  $P^2$
- Homogeneous Coordinates
- Points
- Lines
- Points and Lines at the Infinity
- Intersection of Lines: Points
- Connection of Points: Lines
- Duality