

Decentralized Coordination of Distributed Interdependent Services

Thomas Reicher, Asa MacWilliams, Bernd Bruegge
Chair for Applied Software Engineering
Institut für Informatik
Technische Universität München
(reicher,macwilli,bruegge)@in.tum.de

June 19th 2003

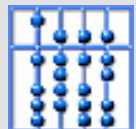

The DWARF Framework

- Mobile AR in ubiquitous computing environments
- Already built AR supported scenarios:
 - Navigation (Pathfinder)
 - Maintenance (TRAMP)
 - Multi-Player Game (SHEEP)
 - Collaborative Building Design (ARCHIE)

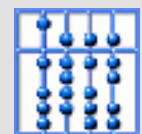
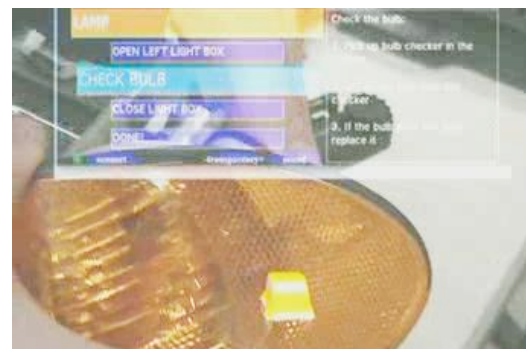

Problems

- Goal: Seamless integration of local and remote components
 - DWARF uses a distributed approach
 - No separation between local and remote component on architectural layer
- Components offer own services and need other services
 - > service interdependency
 - Applications are not simply star-shaped but build a service graph of interdependent services
- Services are distributed on several deployment units
 - > no centralized coordination and configuration possible
- Usually 10 to 50 services per application

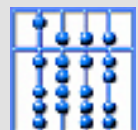

Example

- A View component needs position and orientation data
- A Tracker can provide orientation data in a particular format
- A Filter component must translate between Tracker and View
- The Tracker needs feature information for image processing

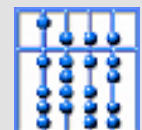
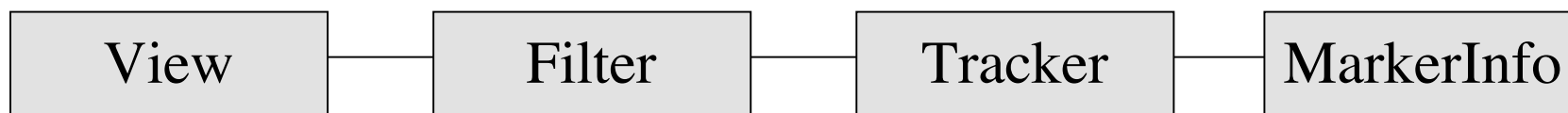

Approach

- Service model for interdependent services
 - Service have Attributes and Predicates.
 - They can be variables which are set at runtime.
- Runtime Infrastructure establishes connection between service automatically (management, lookup, connection)

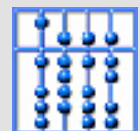
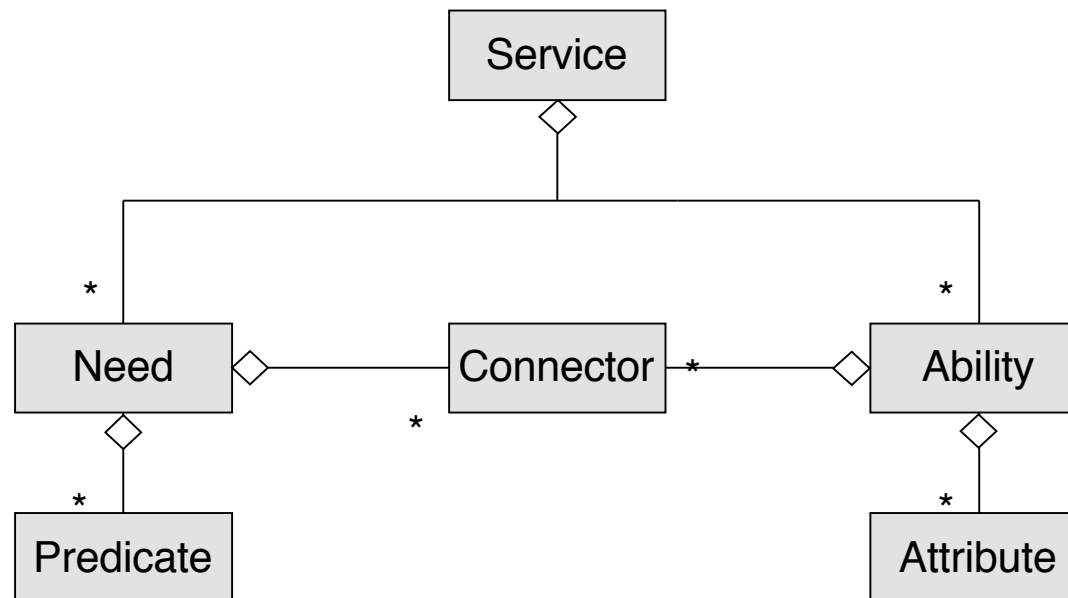

Example Service: Optical Tracker

```
<service name="OpticalTracker">
  <attribute name="Room" value="Studio"/>
  <attribute name="Lag" value="0.01"/>
  <attribute name="Accuracy" value="0.001"/>
  <need name="markerData" type="MarkerData"
    predicate="(&(Thing=*)(User=*))">
    <connector protocol="ObjrefImport"/>
  </need>
  <need name="videoStream" type="VideoStream">
    <connector protocol="RTSPReceive"/>
  </need>
  <ability name="poseData" type="PoseData"
    isTemplate="true">
    <attribute name="Thing"
      value="$(markerData.Thing)">
    <attribute name="User"
      value="$(markerData.User)">
    <connector protocol="NotificationPush"/>
  </ability>
</service>
```

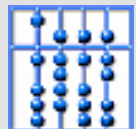
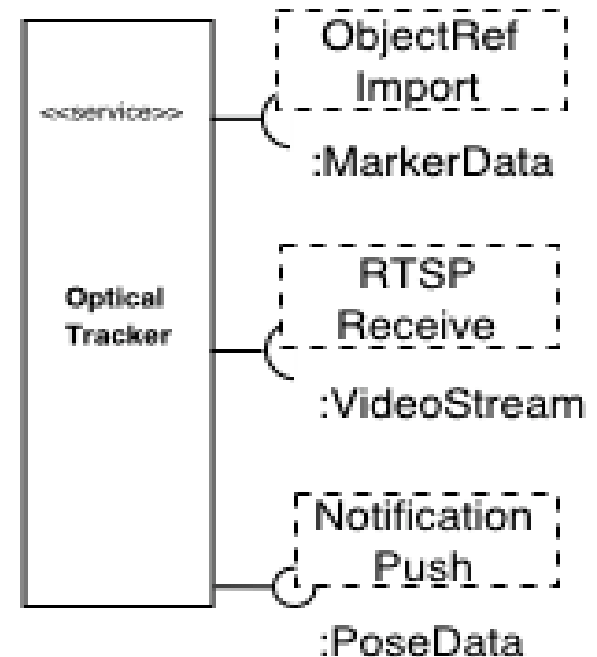

Service Chains

- Service instantiation
 - *Singleton Services* exist only once
 - *Template Services* have multiple instances and can be started on demand by the runtime environment
- Formation of chains of services
 - Services are connected automatically based on *context* and *service-specific attributes*
 - Attribute values are *handed over* from Abilities to Needs
- Services for configuration
 - Service are configured through *Configuration Services*
 - Selection of the correct one over context attributes
 - *Selector Service* for user defined connection

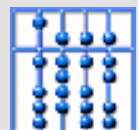

Setup of a Service Chain

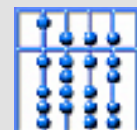
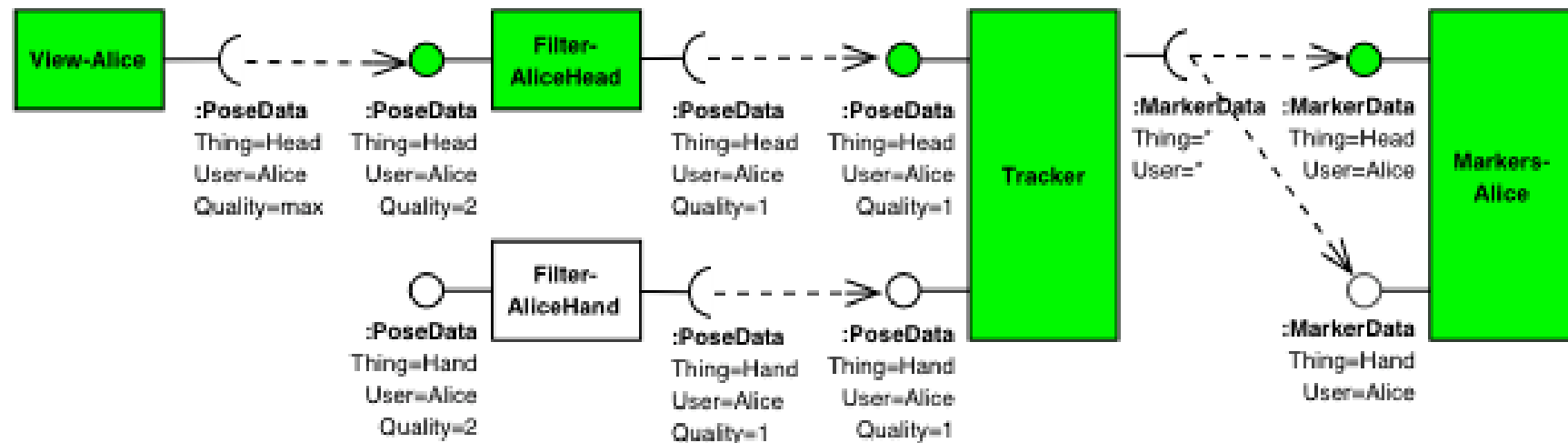
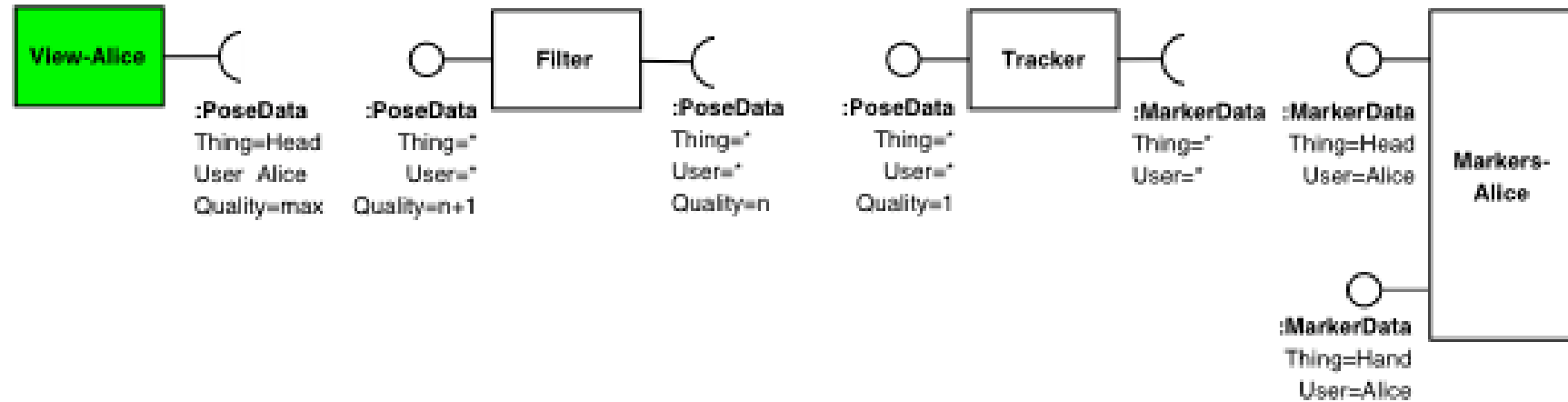

Conclusion

- Service model used for several AR applications
- Configuration Service and Selector Service are being tested
- Hops of Attribute values from Abilities to Needs work. Particularly needed for selection of correct Configuration Service instance
- There are use cases for the opposite way, from Need to Ability
- Simulations and tests needed to find best set of context attributes for clear service selection

