



Interdisciplinary Project (IDP) Final-Presentation

A mixed reality application for needle targeting with trifocal stereo in real-time

Date:	31. Juli 2018
Student:	Thomas Sennebogen
Supervisor:	Benjamin Busam
Supervisor:	Christoph Hennersperger

A mixed reality application for needle targeting with trifocal stereo in real-time

Background information:

- Increasing number of surgical needle interventions
- Use Cases: Cancer Screening, Neurology, Sentinel Lymph Node Biopsy, ...
- Punch Biopsy with Ultrasound transducer

Problem:

- Needle tip location difficult to estimate
- Needle path and bending uncertain

Solution:

- Needle tracking with real-time visualization
- Estimation of the needle bending
- Result: ▶ increasing safety and efficiency
▶ faster healing by minimally invasive surgery

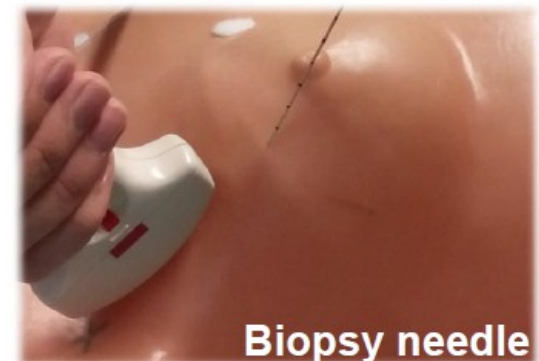
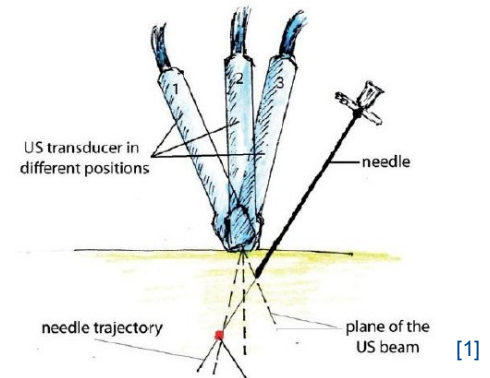

[1] M. Esposito, B. Busam et al.: "Cooperative Robotic Gamma Imaging: Enhancing US-guided Needle Biopsy", MICCAI, 2015 (30.7.2018)

State of the art – Needle Targeting

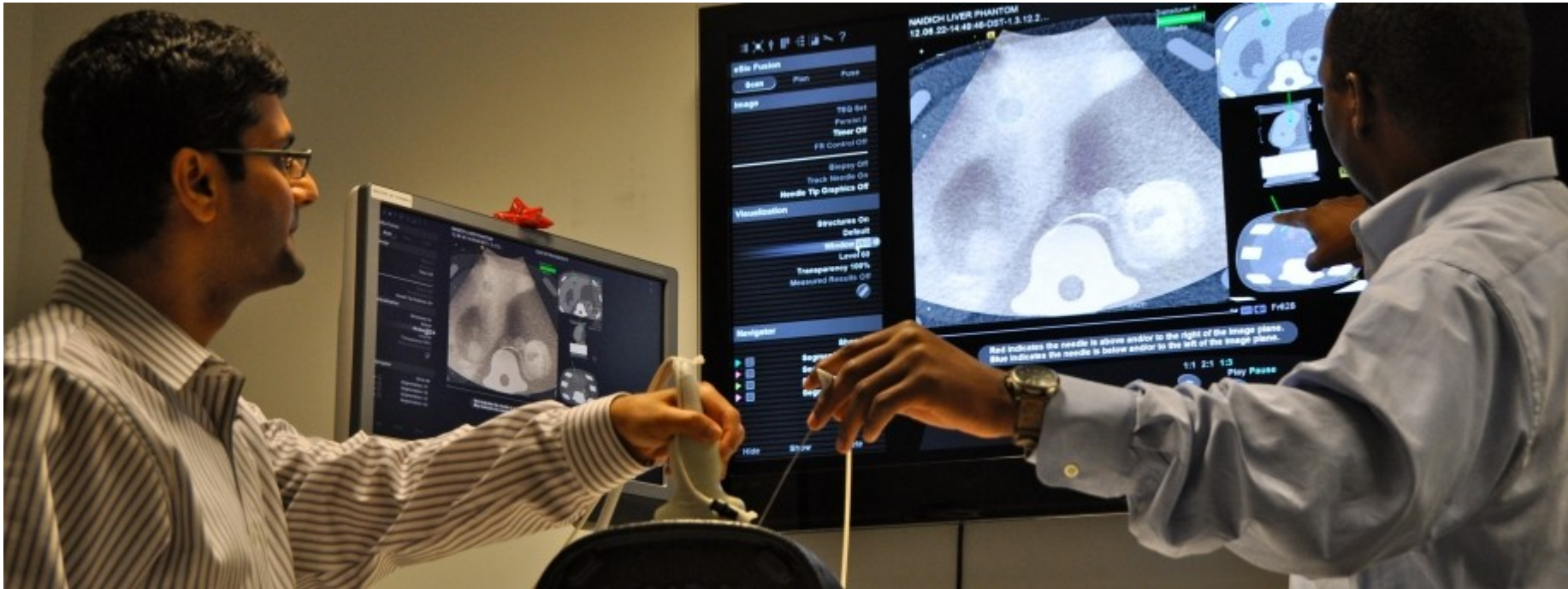

[1]



[1] Siemens Health, https://www.siemens.com/innovation/en/home/publications/health-and-well-being/medical-imaging-opening-a-3-d-window/_jcr_content/gem.adapt.916.high.jpg/1434541043734.jpg (30.7.2018)

State of the art – Needle Targeting

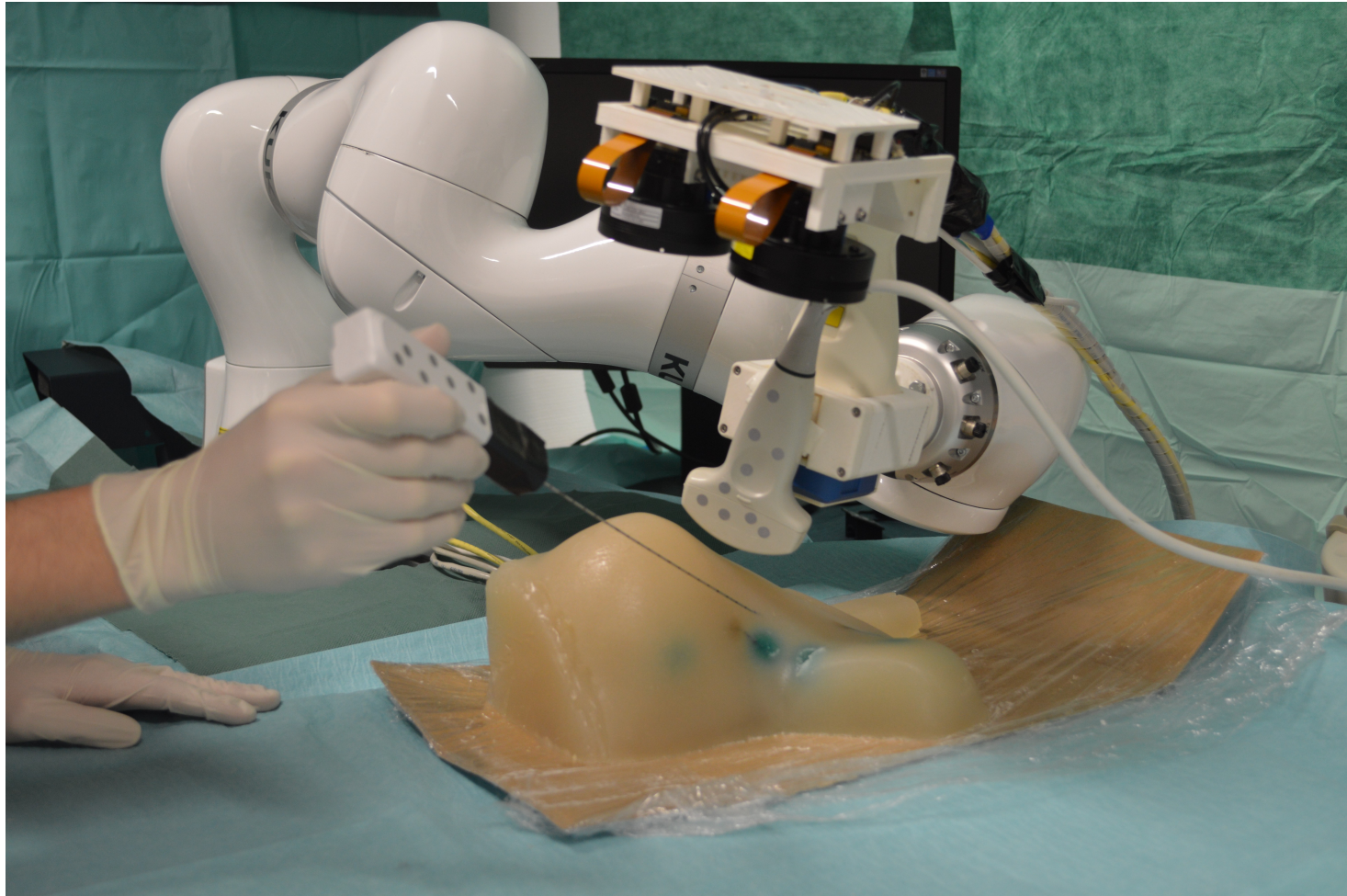

[1]

[1] Needle Targeting at IFL



Needle targeting operation

Trifocal camera system



Needle [1]

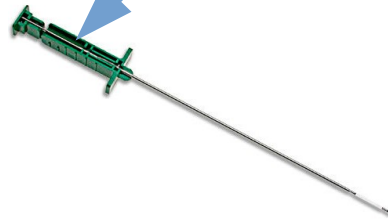

Ultrasound transducer [2]

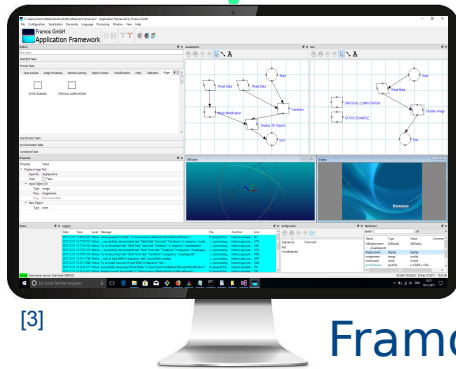
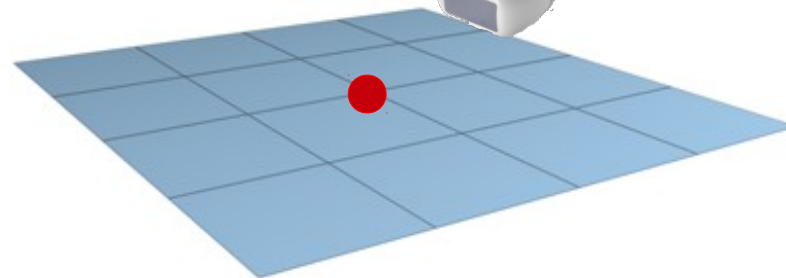

Framos software

[3]

- [1] Biopsy Needle, <https://sep.yimg.com/ay/yhst-12533177228474/needle-biopsy-soft-tissue-14x3-10-box-8.gif> (30.7.2018)
- [2] Ultrasound-Transducer, <https://mindrayamerica.com/wp-content/uploads/MINDRAY-P10-4E-Phased-Array-Ultrasound-Transducer-For-Sale.jpg> (30.7.2018)
- [3] Computer Screen, <http://www.aviatainc.com/wp-content/uploads/2014/11/imac-computer-screen-widescreen-2.png> (30.7.2018)



Needle targeting operation

Trifocal camera system



Needle [1]



Ultrasound transducer [2]

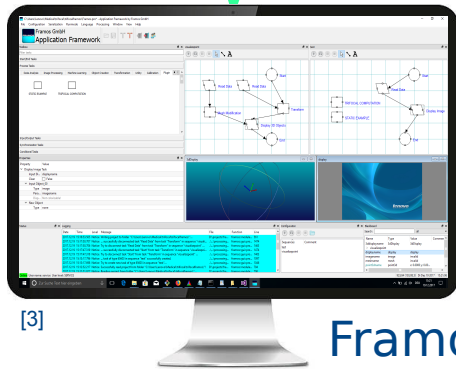

Framos software

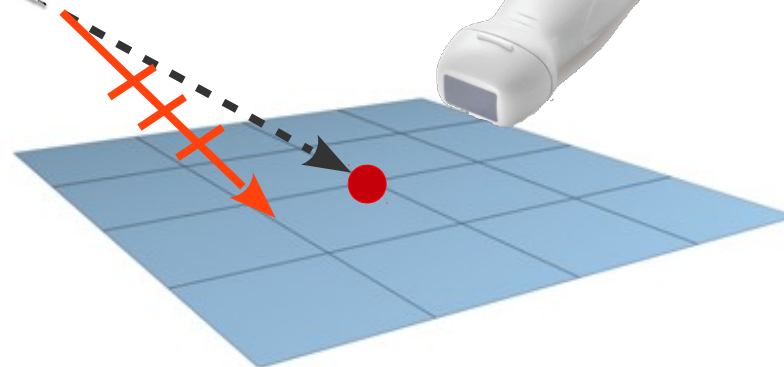

[3]

- [1] Biopsy Needle, <https://sep.yimg.com/ay/yhst-12533177228474/needle-biopsy-soft-tissue-14x3-10-box-8.gif> (30.7.2018)
- [2] Ultrasound-Transducer, <https://mindrayamerica.com/wp-content/uploads/MINDRAY-P10-4E-Phased-Array-Ultrasound-Transducer-For-Sale.jpg> (30.7.2018)
- [3] Computer Screen, <http://www.aviatainc.com/wp-content/uploads/2014/11/imac-computer-screen-widescreen-2.png> (30.7.2018)



Needle targeting operation

Trifocal camera system



Needle [1]



Ultrasound transducer [2]

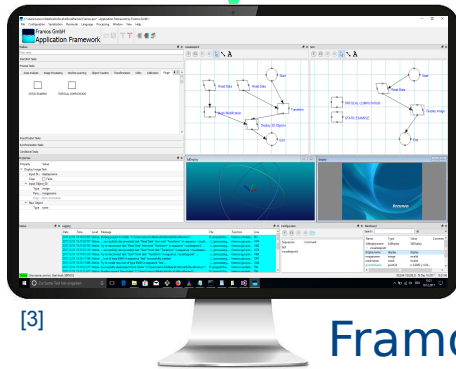

[3] Framos software

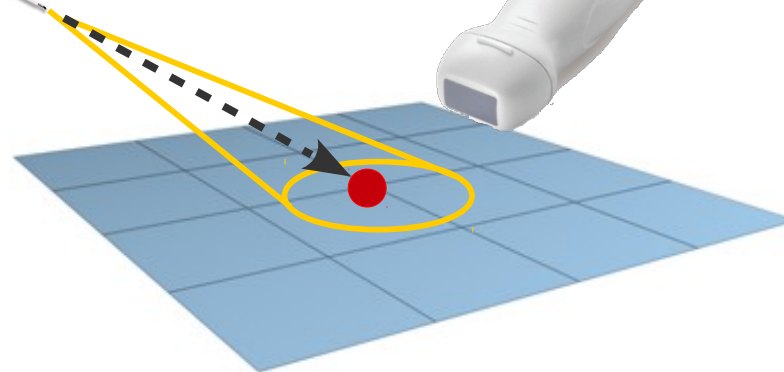

[1] Biopsy Needle, <https://sep.yimg.com/ay/yhst-12533177228474/needle-biopsy-soft-tissue-14x3-10-box-8.gif> (30.7.2018)

[2] Ultrasound-Transducer, <https://mindrayamerica.com/wp-content/uploads/MINDRAY-P10-4E-Phased-Array-Ultrasound-Transducer-For-Sale.jpg> (30.7.2018)

[3] Computer Screen, <http://www.aviatainc.com/wp-content/uploads/2014/11/imac-computer-screen-widescreen-2.png> (30.7.2018)



Needle targeting operation

Trifocal camera system



Needle [1]



Ultrasound transducer [2]

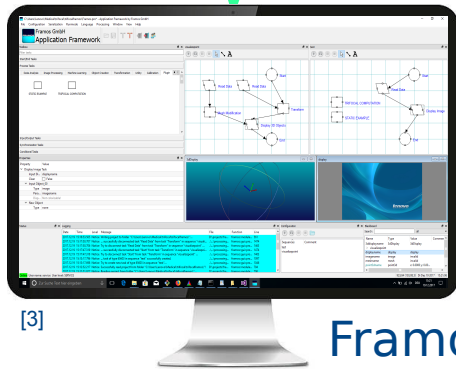

[3]

Framos software

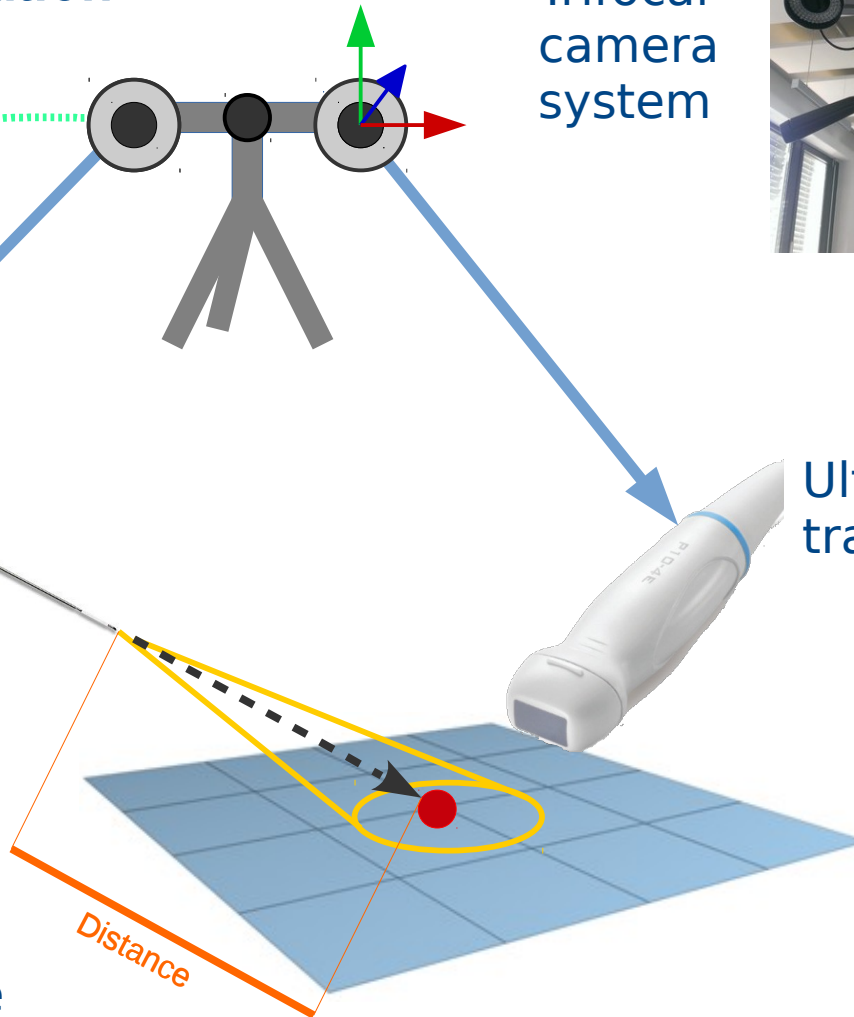

[1] Biopsy Needle, <https://sep.yimg.com/ay/yhst-12533177228474/needle-biopsy-soft-tissue-14x3-10-box-8.gif> (30.7.2018)

[2] Ultrasound-Transducer, <https://mindrayamerica.com/wp-content/uploads/MINDRAY-P10-4E-Phased-Array-Ultrasound-Transducer-For-Sale.jpg> (30.7.2018)

[3] Computer Screen, <http://www.aviatainc.com/wp-content/uploads/2014/11/imac-computer-screen-widescreen-2.png> (30.7.2018)



Needle targeting operation

Trifocal camera system



Needle [1]

Ultrasound transducer [2]

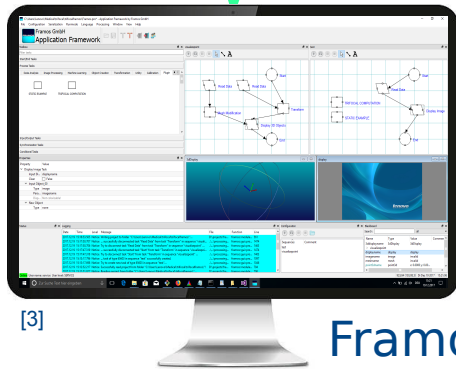

Framos software

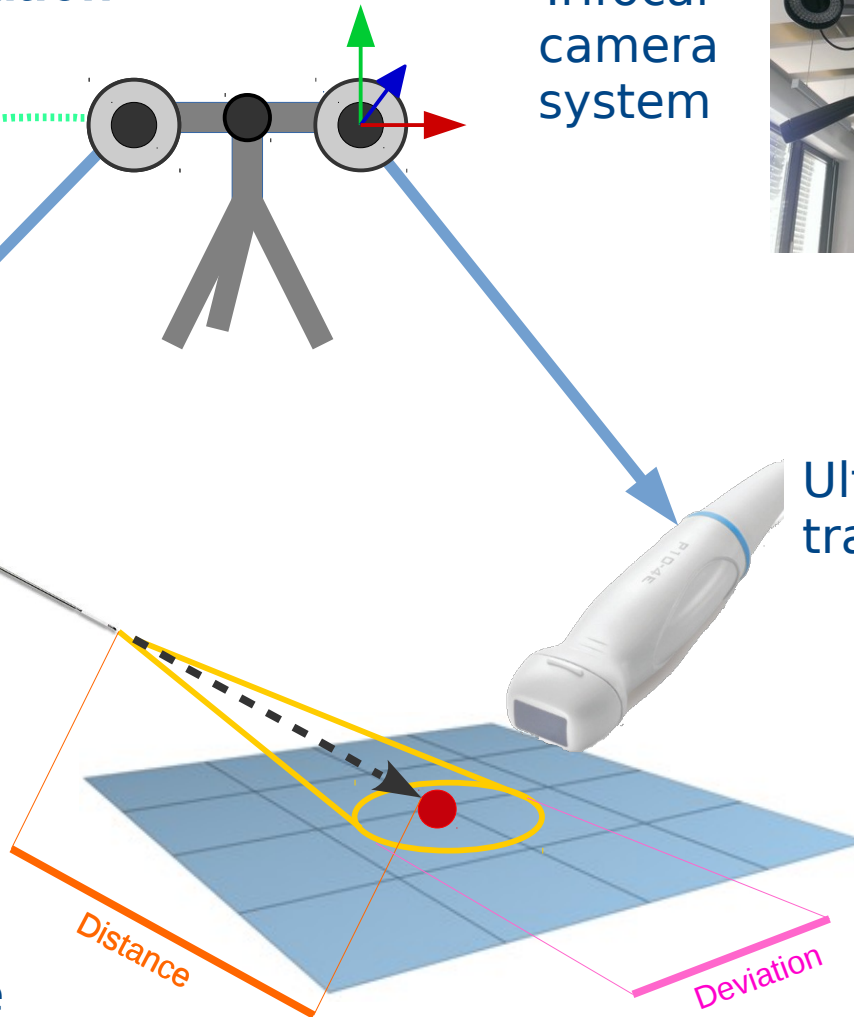

- [1] Biopsy Needle, <https://sep.yimg.com/ay/yhst-12533177228474/needle-biopsy-soft-tissue-14x3-10-box-8.gif> (30.7.2018)
- [2] Ultrasound-Transducer, <https://mindrayamerica.com/wp-content/uploads/MINDRAY-P10-4E-Phased-Array-Ultrasound-Transducer-For-Sale.jpg> (30.7.2018)
- [3] Computer Screen, <http://www.aviatainc.com/wp-content/uploads/2014/11/imac-computer-screen-widescreen-2.png> (30.7.2018)



Needle targeting operation

Trifocal camera system



Needle [1]



Ultrasound transducer [2]

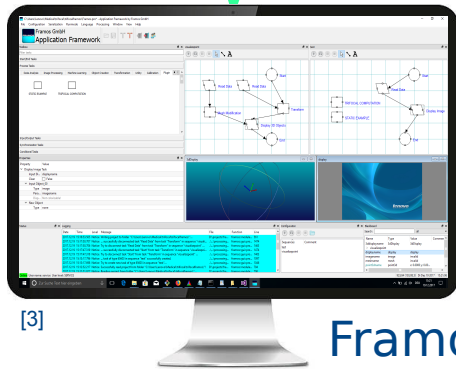

Framos software

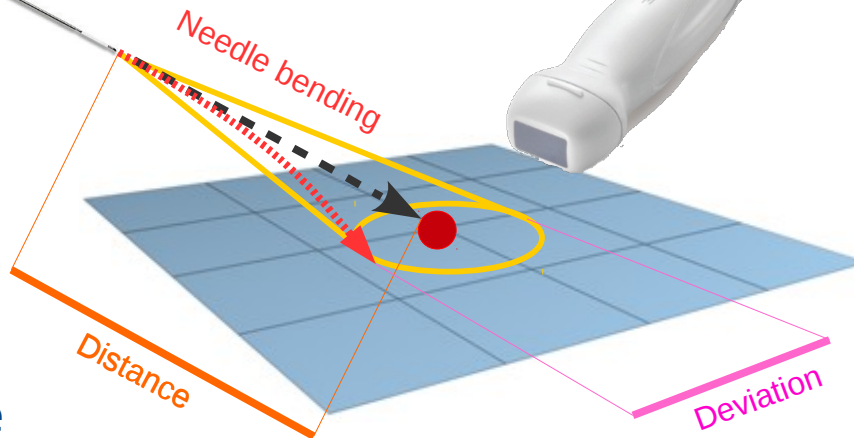

- [1] Biopsy Needle, <https://sep.yimg.com/ay/yhst-12533177228474/needle-biopsy-soft-tissue-14x3-10-box-8.gif> (30.7.2018)
- [2] Ultrasound-Transducer, <https://mindrayamerica.com/wp-content/uploads/MINDRAY-P10-4E-Phased-Array-Ultrasound-Transducer-For-Sale.jpg> (30.7.2018)
- [3] Computer Screen, <http://www.aviatainc.com/wp-content/uploads/2014/11/imac-computer-screen-widescreen-2.png> (30.7.2018)



Software structure

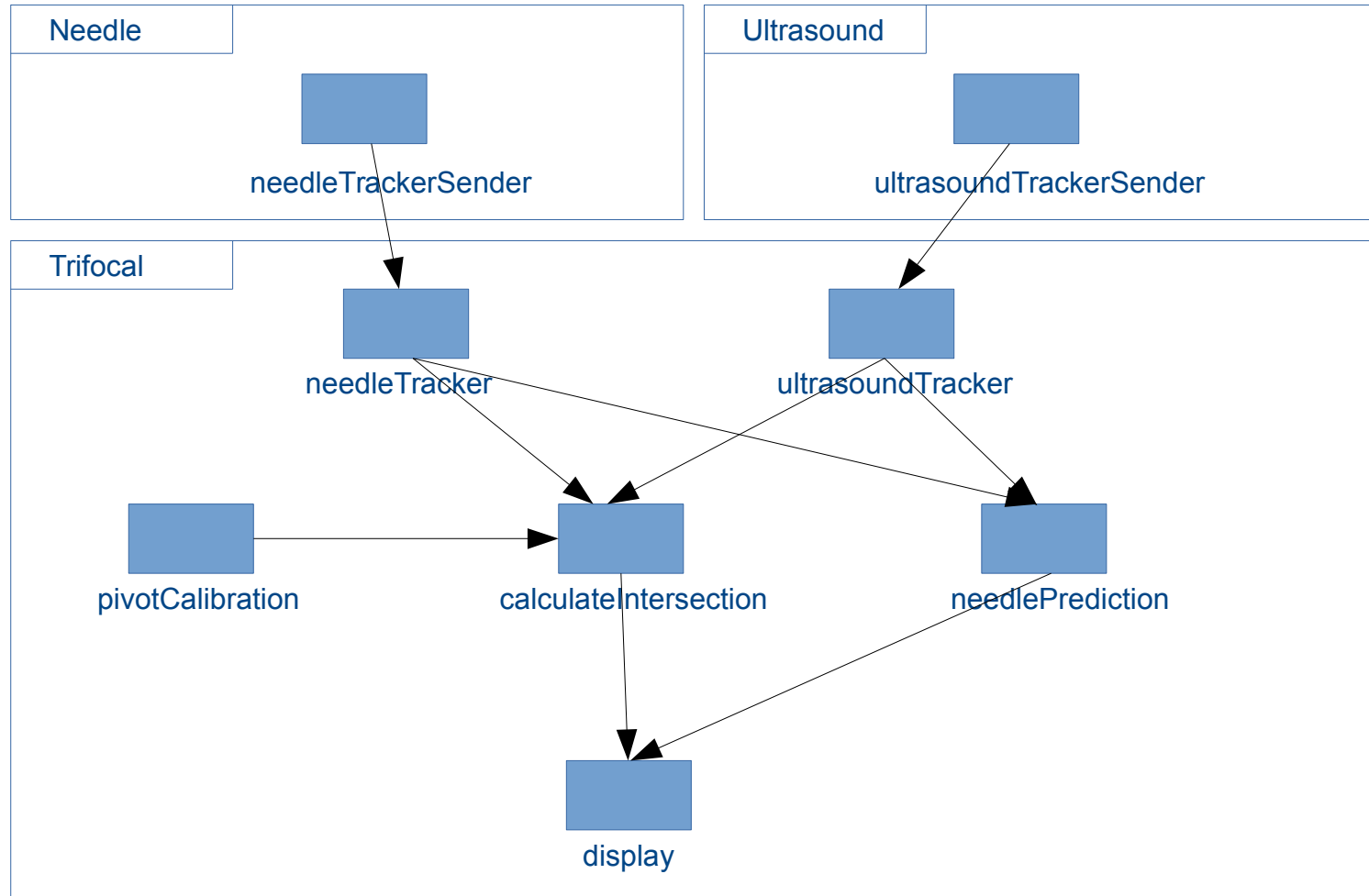

7 FRAMOS plugins

NeedleTracker

- is receiving needle poses via OpenIGTLink from Server
- Input: -
- Output: Needle Pose

NeedleTrackerSender

- is sending needle poses via OpenIGTLink to the NeedleTracker
- Input: -
- Output: -

UltrasoundTracker

- is receiving ultrasound pose and image via OpenIGTLink sender
- Input: -
- Output: Ultrasound Pose, Image

UltrasoundTrackerSender:

- is sending poses and images to the UltrasoundTracker
- Input: -
- Output: -



7 FRAMOS plugins

AcquireImage

- is used by Framos to display images

UltrasoundPlane

- is a static transformation to deal with the ultrasound plane

PivotCalibration

- is used to measure the needle tip from handle
- Linear equation system (SVD)
- Input: Pose Array
- Output: Pose

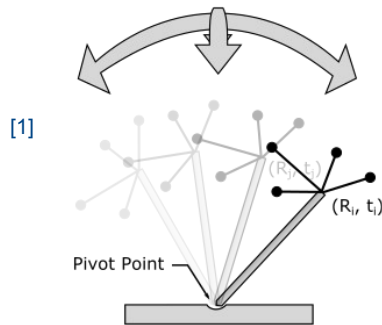
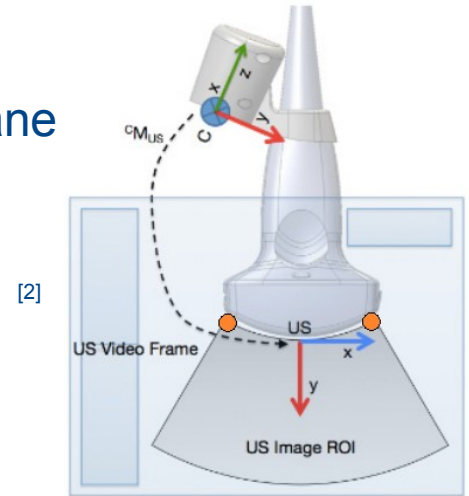

$$\begin{bmatrix} R_1 & -1 \\ \vdots & \vdots \\ R_n & -1 \end{bmatrix} \begin{bmatrix} P_{TCS} \\ P_{WCS} \end{bmatrix} = \begin{bmatrix} -t_1 \\ \vdots \\ -t_n \end{bmatrix}$$



[1] Pivot Calibration, http://rwthmeditec.github.io/TRTK/html/class_t_r_t_k_1_1_pivot_calibration.html (30.7.2018)
 [2] Stolka, Philipp J., et al. "Needle guidance using handheld stereo vision and projection for ultrasound-based interventions." Medical Image Computing and Computer-Assisted Intervention–MICCAI 2014. Springer International Publishing, 2014. 684-691. (30.7.2018)

7 FRAMOS plugins

NeedlePrediction

- is used for predicting the future needle path based on the needle vector
- Input: Pose Array
- Output: 5 indication points / ply cylinder

CalculateIntersection

- is used to calculate the intersection point between needle and plane and the distance between needle tip and plane
- Input: Plane Pose, Needle tip and direction
- Output: Intersection Point, Distance

[1]

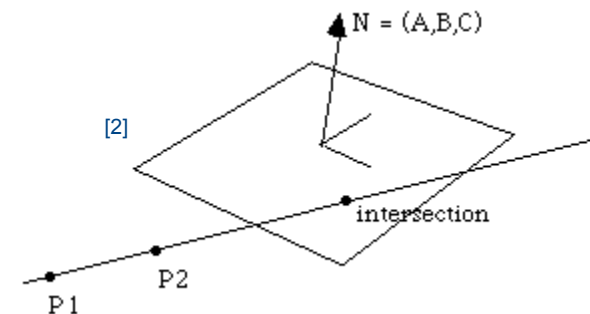
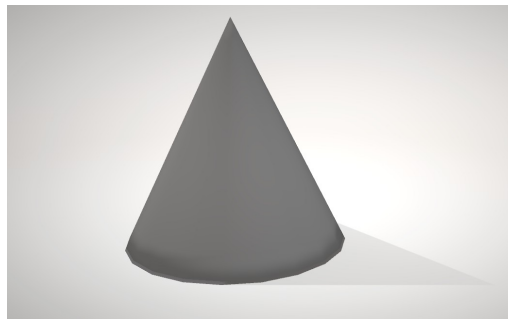

[1] Cylinder ply file

[2] CalculateIntersection. <http://paulbourke.net/geometry/pointlineplane/> (30.7.2018)

FRAMOS Application Framework

C:\Users\Lenovo\Medical\trifocal\trifocalframof\Framos.pro* - Application Framework by Framos GmbH

File Configuration Serialization Runmode Language Processing Window View Help

FRAMOS Framos GmbH Application Framework

visualizepoint Configuration trifocal test

Sequences Comment

UReceiver UTracker test tracker trifocal visualizepoint

Read Data Read Data Start Mesh Modification Display 3D Objects

Sequence Control Mesh Modif Transform Display Im

Sequence Control Display 3D Objects Display

Add Objects

Transform Sensor Command (Deprecated) COMMAND SET Acquire Display 3D Objects Start Read Data Display Image End

Properties

Property	Value
Sequence Control Task	
Sequence	receiver
Comma...	Start Sequence
Mode	single
Single...	Asynchronous
Task Co...	Start Needle (2)

display 3dDisplay

tracker receiver

UTracker USender

Status Logging

Date	Time	Level	Message
2018.07.31	05:55:07.268	Notice	... User "service" logged on successful.
2018.07.31	05:55:06.998	Notice	Try to log on user "service" ...
2018.07.31	05:54:59.200	Notice	System is in online mode!
2018.07.31	05:54:59.200	Notice	User "" is switching system to online mode...
2018.07.31	05:54:59.106	Notice	Successfully read project from folder "C:\Users\Lenovo\Medical\trifocal\trifocalframof\!"
2018.07.31	05:54:59.078	Warning	The task "Sensor Command (Deprecated)" in sequence "test" is deprecated and will be removed in future versions
2018.07.31	05:54:58.938	Notice	Reading project from folder "C:\Users\Lenovo\Medical\trifocal\trifocalframof\!"
2018.07.31	05:54:58.781	Error	You are running against the wrong Smartek GigE Vision SDK version, you are currently using 3.2.0.0. Please use version 3.3.1.0 instead!
2018.07.31	05:54:58.781	Infor...	Loaded "Smartek CameraSuite" version: "3.2.0.0"

Blackboard

Name	Type	Value
3ddisplayname	3dDisplay	3dDi...
displayname	display	displ...
doublename	double	0.000
imagename	image	inval...
meshname	mesh	inval...
point3dname	point3d	xx: 0.0
pointcloud3dna...	pointcloud3d	inval...
noseArrav	nose arrav	Size:...

Online User name: service User level: SERVICE

Zur Suche Text hier eingeben

128;92 (50) Di Jul 31 2018 06:15:05

06:15 31.07.2018



Milestones and Project plan

- Familiarization with the topic and research - Alexandre Krupa:
„3D ultrasound-guided robotic steering of a flexible needle via visual servoing“
- Designing the concept
- Implementation and integration
 - Famos software framework with C++
 - 3D representation with OpenGL and OpenCV
 - Stereo tracking poses via OpenIGTLink
 - Integrate image transfer with plugins
 - Calibrate cameras and needle
(intrinsic, extrinsic, needle, pivot, ultrasound)
 - Calculate and visualize additional information
- Build prototype
- Verification, validation and testing
- Documentation (GIT) and presentation



Time Line for the project – GANNT Chart

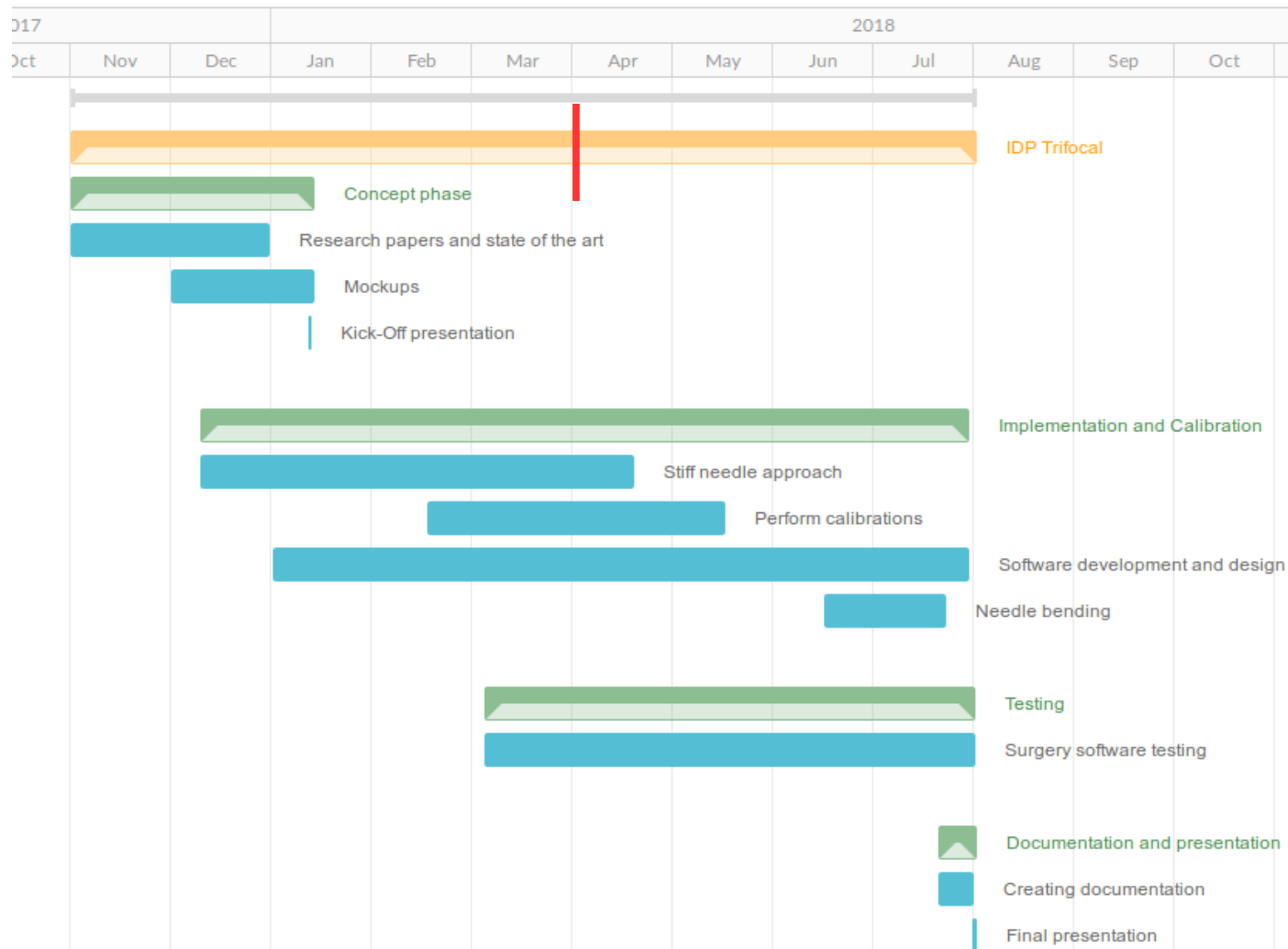

[1] Created with GanttPRO, <https://app.ganttpro.com>



Software Engineering



[1]



[2]



[3]



[4]



[5]



[6]



[7]

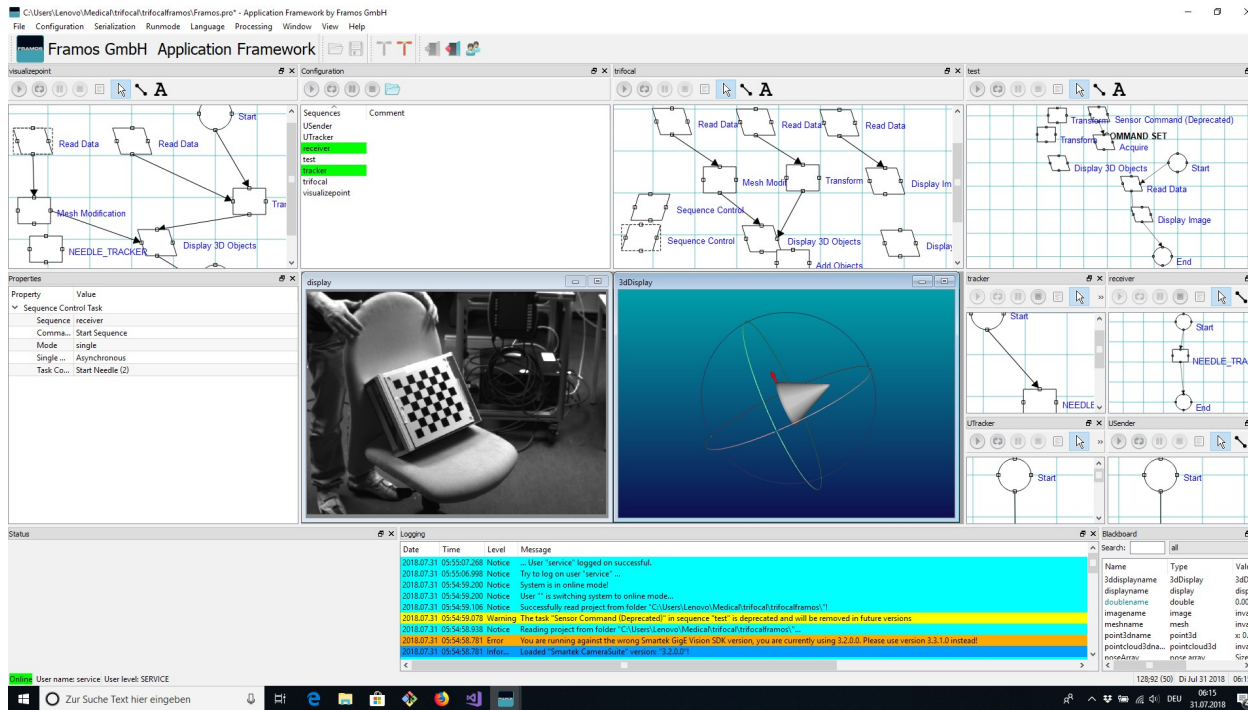

- [1] C++, <https://pluralsight.imgix.net/paths/path-icons/c-plus-plus-93c7ddd5cc.png> (30.7.2018)
- [2] FRAMOS GmbH, <https://www.framos.com/media/image/01/66/f6/Desktop58b848cb02ebc.png> (30.7.2018)
- [3] Visual Studio, <http://blog.parallels.com/2017/03/07/visual-studio-2017/> (30.7.2018)
- [4] OpenIGTLink, <https://www.slicer.org/w/images/thumb/3/3f/OpenIGTLink-Logo.png/250px-OpenIGTLink-Logo.png> (30.7.2018)
- [5] Eigen, http://eigen.tuxfamily.org/images/Eigen_Silly_Professor_135x135.png (30.7.2018)
- [6] OpenCV, <https://opencv.org/assets/theme/logo.png> (30.7.2018)
- [7] GIT, <https://avatars1.githubusercontent.com/u/18133?s=400&v=4> (30.7.2018)



Project partners

FRAMOS GmbH

- Using the FRAMOS software framework
- Trifocal camera system



[1]

Klinikum Rechts der Isar

- Premises at the hospital: IFL
- Resources



Klinikum rechts der Isar [2]

CAMP chair:

- Interdisciplinary Project (IDP)
- Supervisors



[3]



[1] FRAMOS GmbH, <https://www.amos.com/media/image/01/66/f6/Desktop58b848cb02ebc.png> (30.7.2018)

[2] Klinikum rechts der Isar, <https://kress.de/news/detail/beitrag/136314-job-des-tages-online-redakteur-mw-in-muenchen-gesucht.html> (30.7.2018)

[3] TUM, CAMP chair, <http://campar.in.tum.de> (30.7.2018)

Additional considerations

Calibration with Optical Tracking System (OTS):

- Needle: handle, tip, vector
- Ultrasound: handle, plane
- Cameras: intrinsic, extrinsic

Needle bending aspects:

- Material stiffness
- Needle length
- Tissue to investigate
- Model of deviation error

Software development problems

- Utilizing dependencies and libraries
- Dealing with input and output values
- OpenIGTLink sending process



Project summary and outlook

Suggestions for improvement

- Better visualization of needle bending
- More accuracy and insert real data
- Improving task workflow
- Change software framework
- Missing functionality: Select the target, insertionpoint
- Rather Proof of concept than usable for real biopsies

Future work:

- Using additional preoperative MRT
- Verify and improve functionality
- Additional software features
- Video recordings of surgery for teaching
- Robotic surgery



Thank you for your attention!

Interdisciplinary Project (IDP)

**A mixed reality application for needle targeting
with trifocal stereo in real-time**

Date: 31. Juli 2018
Student: Thomas Sennebogen
Supervisor: Benjamin Busam
Supervisor: Christoph Hennesperger

