

Felix Scheidhammer,
supervised by Benjamin Busam, Christoph Hennersperger



BA Kickoff:
Pose-aware rendering of
live ultrasound data
for mixed medical AR



Structure

- Motivation
- Goal
- State-of-the-Art
- Setup
- Messaging System
- Timeline
 - Calibration
 - Forward - Kinematic
- Rendering
- Progress
- Questions



Motivation

- Augmenting live Data
- On a Smartphone (costs, availability, complexity, extendability)
- Precise (Optical Tracking System)
- find again past measures with Live-Guidance



Goal

- Augmenting tracked live ultrasound data on a tracked Android device (Tablet, Smartphone, Google Cardboard)
- Live Guidance to find past measures

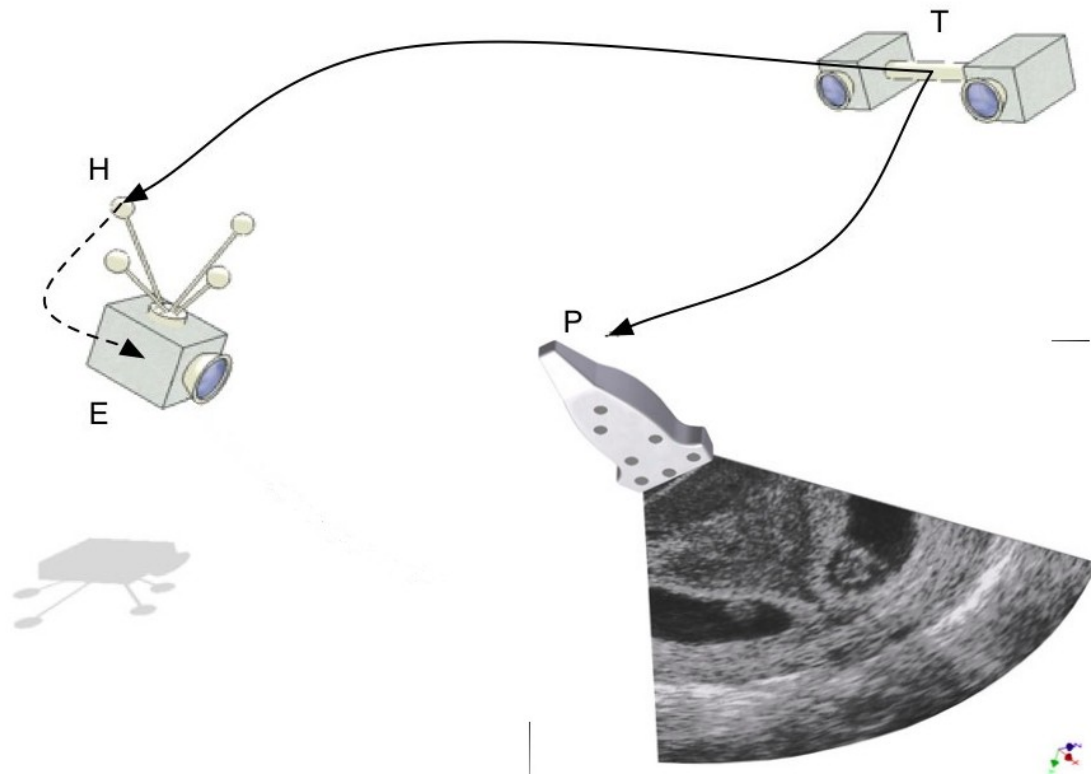

<http://campar.in.tum.de/Chair/HandEyeCalibration> 05/09/17 and
<https://www.framos.com/us/solutions/medical/optical-tracking-system/> 05/09/17



Not State-of-the-Art

- „live“ Ultrasound Data (1-2 fps) augmented on a see through HMD in 1992
- Polhemus Tracking System (uses electro magnetic fields)

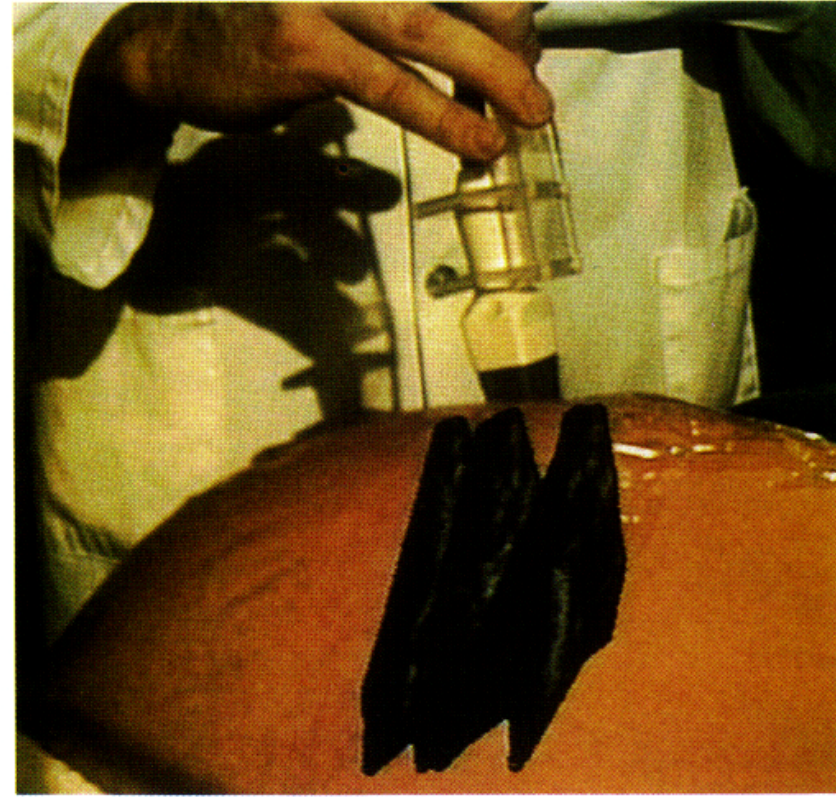

Bajura, Michael & Fuchs, Henry & Ohbuchi, Ryutarou. (1992). Merging virtual objects with the real world: Seeing ultrasound imagery within the patient. ACM Siggraph Computer Graphics. 26. 203-210. 10.1145/142920.134061.



State-of-the-Art

- Modified Sony Glasstron LDI-D100 HMD
- Image-Guided Technologies FlashPoint™ 5000 optoelectronic tracker



Rosenthal M. et al. (2001) Augmented Reality Guidance for Needle Biopsies: A Randomized, Controlled Trial in Phantoms. In: Niessen W.J., Viergever M.A. (eds) Medical Image Computing and Computer-Assisted Intervention – MICCAI 2001. MICCAI 2001. Lecture Notes in Computer Science, vol 2208. Springer, Berlin, Heidelberg 07/09/17



State-of-the-Art

- Teaching System for the use of Ultrasound Device
- Mobile live AR on iOS and Android
- Marker based Tracking (Vuforia)

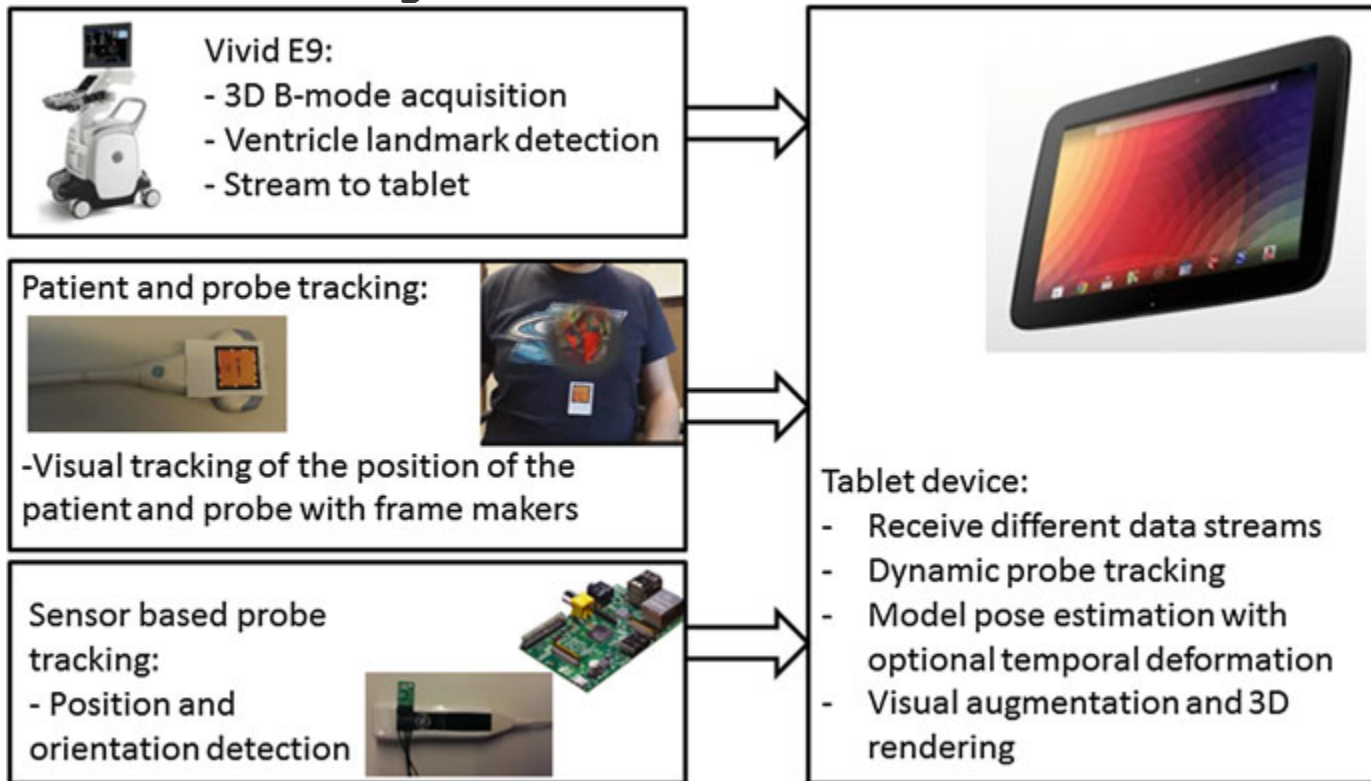

Kiss G., Palmer C.L., Torp H. (2015) Patient Adapted Augmented Reality System for Real-Time Echocardiographic Applications. In: Linte C., Yaniv Z., Fallavollita P. (eds) Augmented Environments for Computer-Assisted Interventions. MICCAI 2015. Lecture Notes in Computer Science, vol 9365. Springer, Cham



State-of-the-Art

- Teaching System for the use of Ultrasound Device
- Mobile live AR on iOS and Android
- Marker based Tracking (Vuforia)

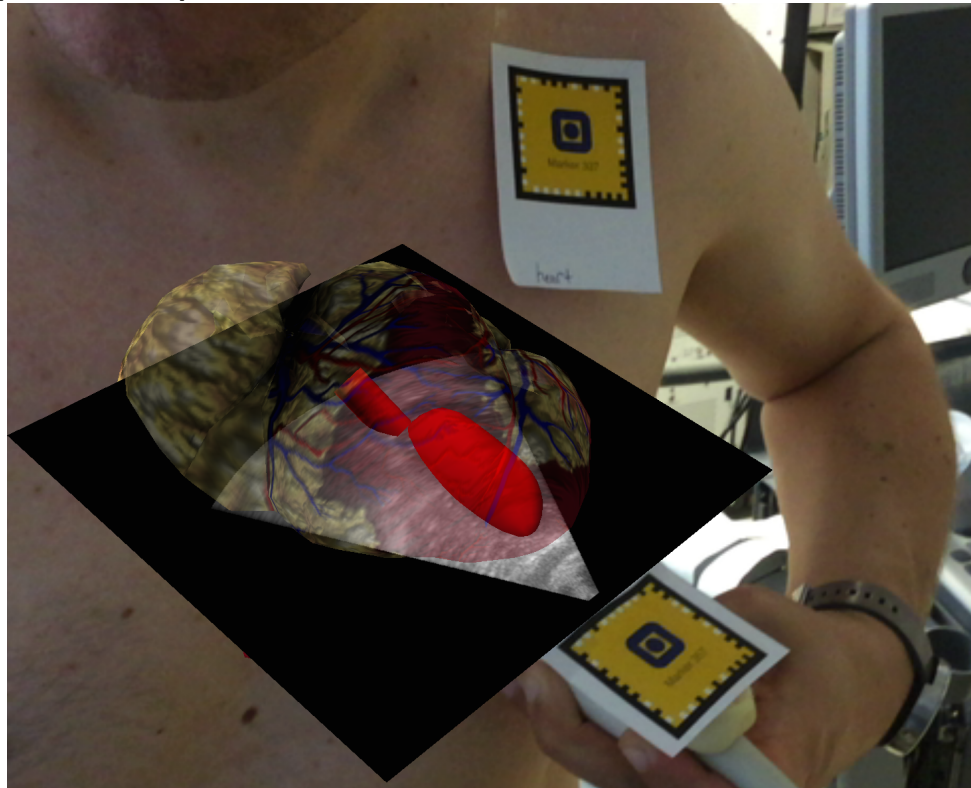

Palmer, C. L., Haugen, B. O., Tegnander, E., Eik-Nes, S. H., Torp, H., & Kiss, G. (2015, October). Mobile 3D augmented-reality system for ultrasound applications. In *Ultrasonics Symposium (IUS), 2015 IEEE International* (pp. 1-4). IEEE



State-of-the-Art

- Probe Localization for Freehand 3D Ultrasound by Tracking Skin Features

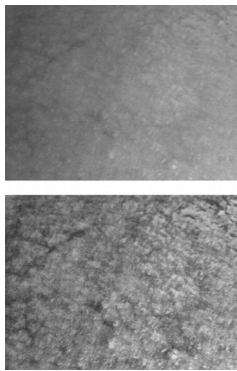
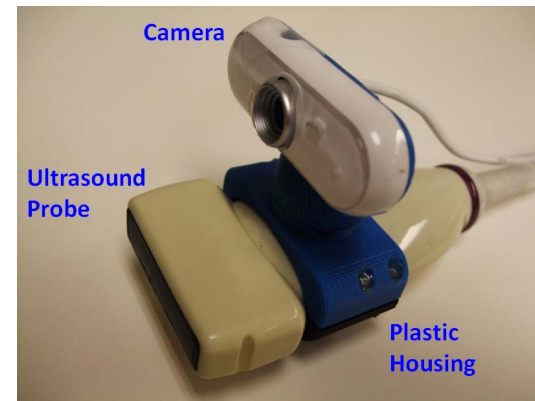

(neck)

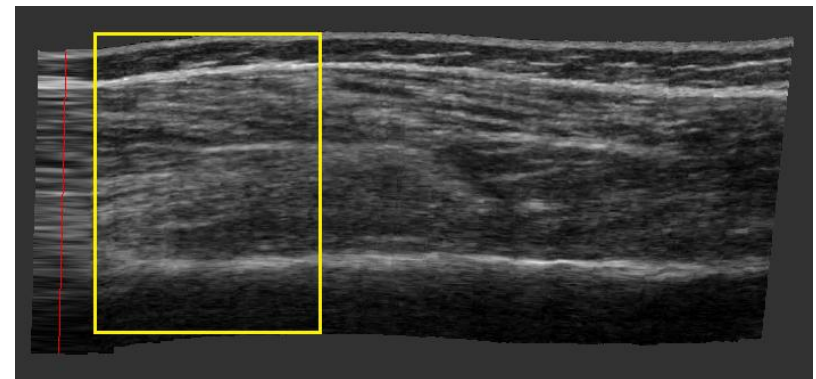
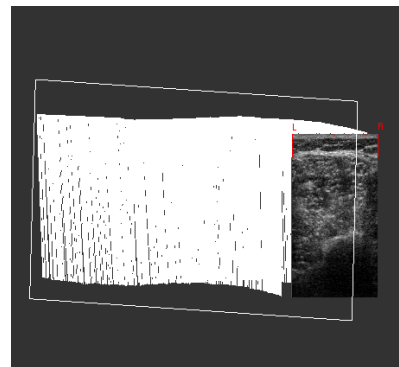

Sun SY., Gilbertson M., Anthony B.W. (2014) Probe Localization for Freehand 3D Ultrasound by Tracking Skin Features. In: Golland P., Hata N., Barillot C., Hornegger J., Howe R. (eds) Medical Image Computing and Computer-Assisted Intervention – MICCAI 2014. MICCAI 2014. Lecture Notes in Computer Science, vol 8674. Springer, Cham

Setup

- Android Smartphone Galaxy J5 (2016)
 - Android 6.0 (API Level 23 or Marshmallow)
 - 5,2" Display
 - Resolution 1280*720 (HD)
 - 2 GB RAM
 - CMOS 13.0MP (aperture F1.9)
 - Video recording with Resolution 1280*720 @30fps

<http://www.samsung.com/ph/smartphones/galaxy-j5-2016-j510gn/SM-J510GZDUXTC/>



Setup

- Android Smartphone
- Ultrasound Device



<https://www.framos.com/us/solutions/medical/optical-tracking-system/> 05/09/17

Setup

- Android Smartphone
- Ultrasound Device
- Switch/Hub for local network
- (stationary) Optical Tracker System

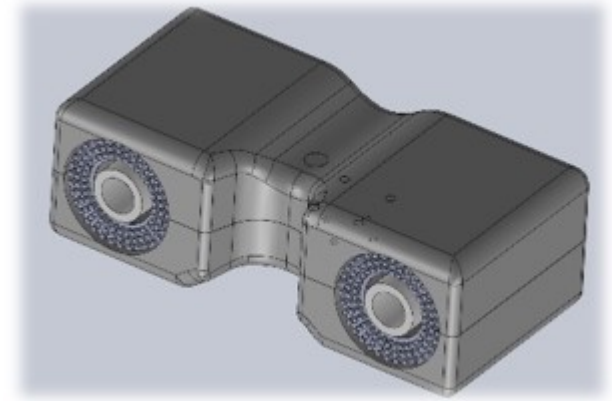

(provided by Benjamin Busam)



Timeline - Calibration of Android Device

- Capture n (~ 10) Pictures and Poses at the same time
- OpenCV: calibrate Pictures [Zhang 2000]
 - Intrinsic Parameters K
 - n extrinsic Parameters $\frac{E}{G}^T \rightarrow n$ same $\frac{E}{H}^T$ known \rightarrow average for precision

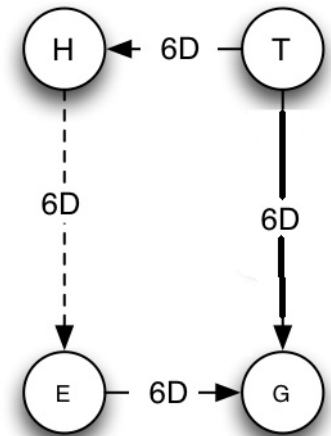
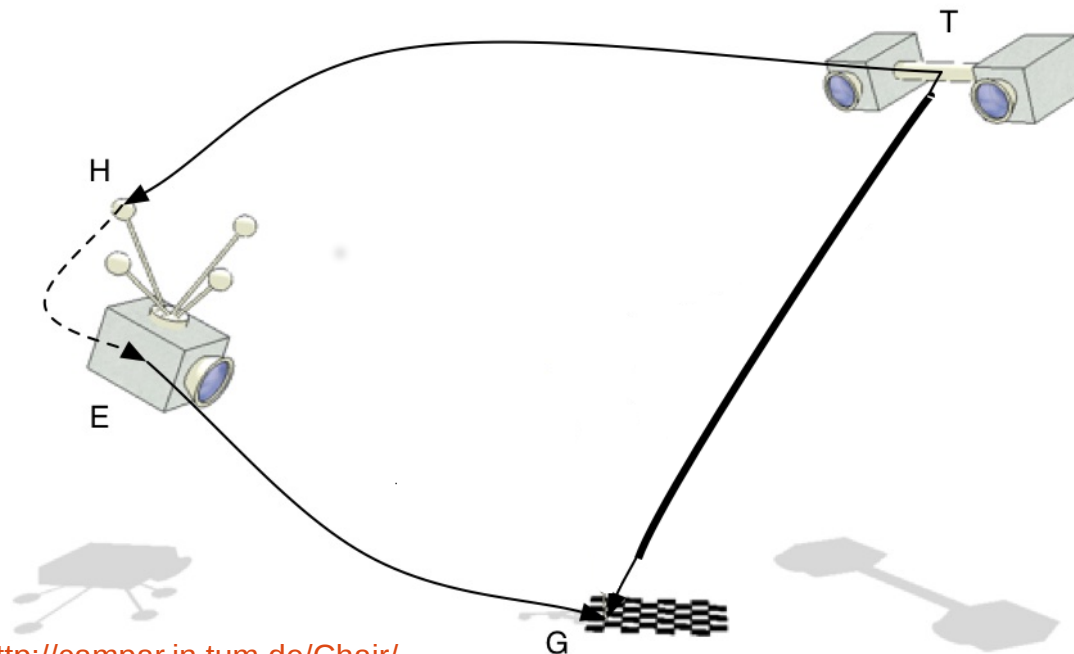

<http://campar.in.tum.de/Chair/HandEyeCalibration>
05/09/17

Zhang. A Flexible New Technique for Camera Calibration. IEEE Transactions on Pattern Analysis and Machine Intelligence, 22(11):1330-1334, 2000.

Rendering

- Distortion correction of received Picture from Camera

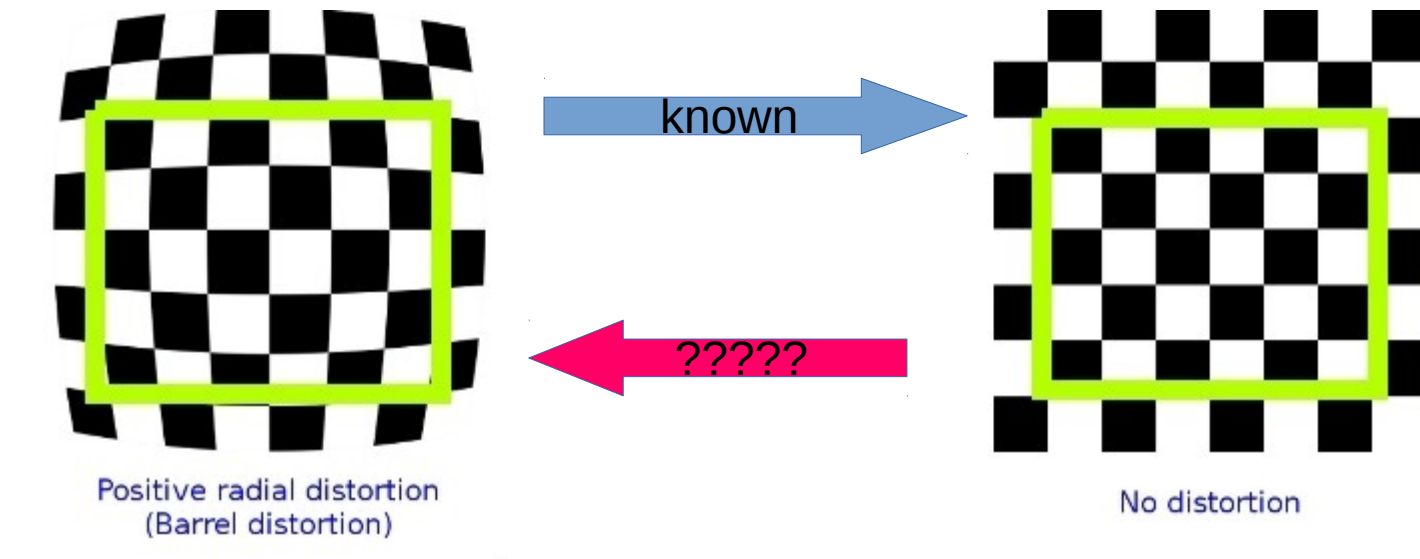

- LookUptable estimated via Newton Raphson Method (root of a polynom)
- Perspective Projection of Ultrasound image via Calibration Parameters

docs.opencv.org/2.4/modules/calib3d/doc/camera_calibration_and_3d_reconstruction.html



Progress

- Start: Brainstorming 16/05/17 official start 15/08/17
- What is done till now:
 - Cameracalibration (OpenCV example with autofocus)
 - LookUpTable for inverse Distortion (without tangential Distortion)
 - Almost calibrated Rendering of Camera (LUT not filled into GL ES)
 - Receiving Trackerdata and Ultrasound Data
 - Not-pose-aware Rendering of Ultrasound Data
- What has to be done:
 - Calibration with Tracked Poses and tangential distortion
 - Calibating Ultrasound Device to the Optical Tracker System
 - Single Rotation Averaging
 - UI for Live-Guidance to find past recorded measures



Questions?



Timeline - Forward Kinematic

- We need Transformation $\frac{E}{H}^T$ from Camera-Pose to Camera-space
- n $\frac{E}{G}^T$ and corresponding tracked Poses $\frac{H}{T}^T$, $\frac{G}{T}^T$ known

and
$$\frac{E}{H}^T = \frac{E}{G}^T \cdot \frac{G}{T}^T \cdot \frac{H}{T}^{-1}$$

- Leads to n times same Transform $\frac{E}{H}^T$
 - Weighted Average of Transform
 - Average Translation Vector
 - Single Rotation Averaging to compute the Karcher Mean
 - [Manton: A globally convergent numerical algorithm for computing the centre of mass on compact Lie groups 2004]

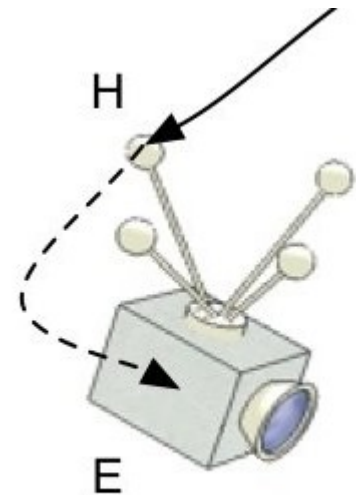

Picture: <http://campar.in.tum.de/Chair/HandEyeCalibration> 05/09/17



Rendering

- Distortion correction of received Picture from Camera

- Known undistortion: $r_u = r_d * (1 + k_1 * r_d^2 + k_2 * r_d^4 + k_3 * r_d^6)$

- But we know r_u and want to know r_d

- Solve: $0 = r_d * (1 + k_1 * r_d^2 + k_2 * r_d^4 + k_3 * r_d^6) - r_u$ for every pixel $\begin{pmatrix} x \\ y \end{pmatrix}; r_u = \sqrt{x^2 + y^2}$

- Store in Look-up-Table

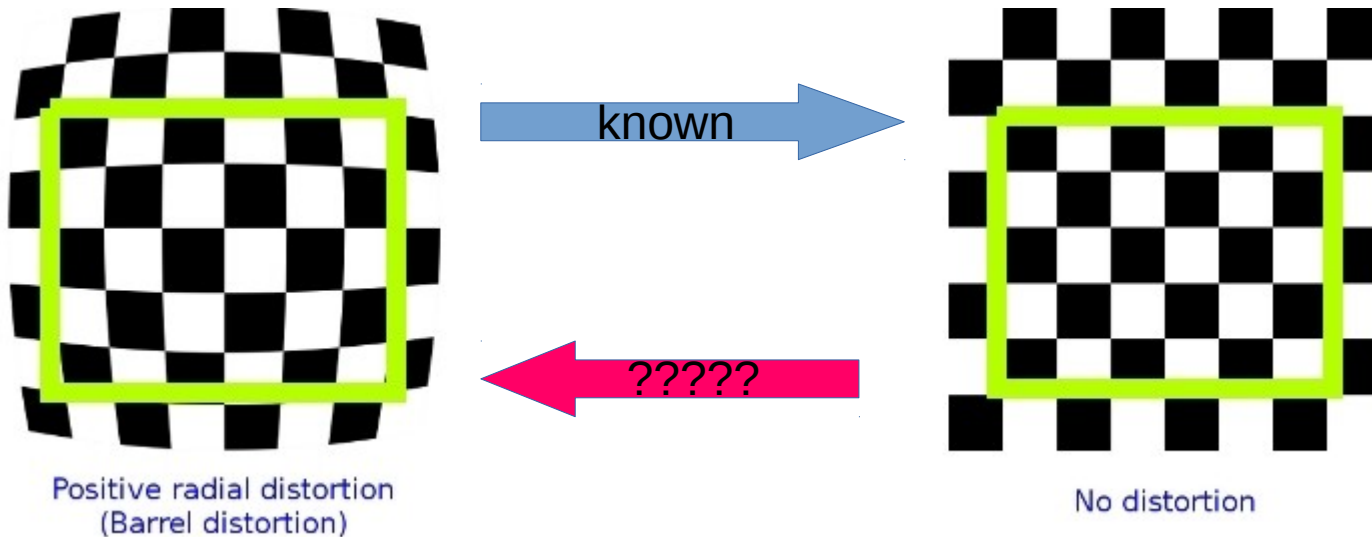

docs.opencv.org/./camera_calibration_and_3d_reconstruction.html



Rendering

- Transform Ultrasound Image to Camera view and use perspective projection to render

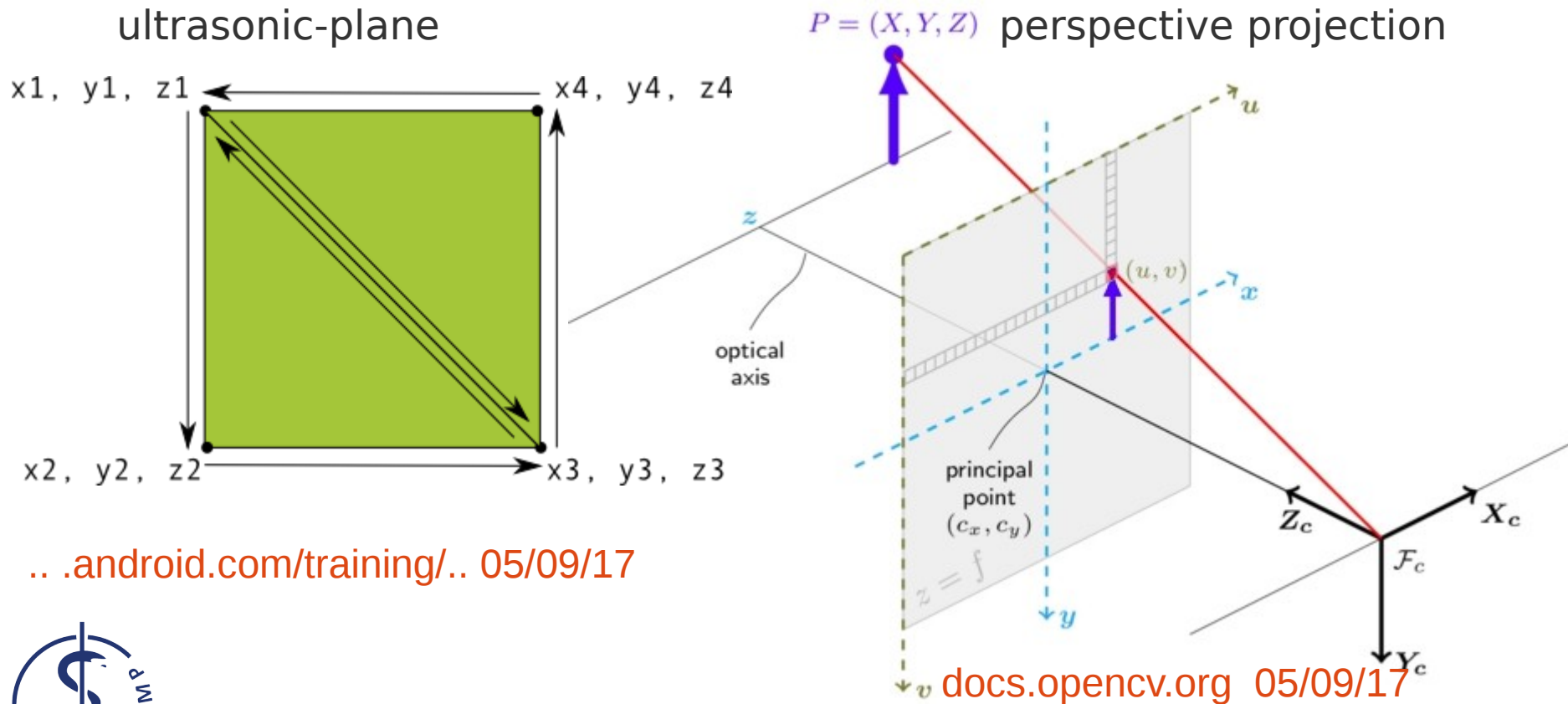

.. [.android.com/training/](https://android.com/training/).. 05/09/17

docs.opencv.org 05/09/17



Rendering

$$\begin{pmatrix} p_x \\ p_y \\ 0 \\ 1 \end{pmatrix} = \begin{pmatrix} 1 & 0 & 0 & 0 \\ 0 & -1 & 0 & 0 \\ 0 & 0 & 0 & 0 \\ 0 & 0 & 0 & 1 \end{pmatrix} * \begin{pmatrix} 1 & 0 & 0 & -1 \\ 0 & 1 & 0 & -1 \\ 0 & 0 & 1 & 0 \\ 0 & 0 & 0 & 1 \end{pmatrix} * \begin{pmatrix} 2/\text{width} & 0 & 0 & 0 \\ 0 & 2/\text{height} & 0 & 0 \\ 0 & 0 & 1 & 0 \\ 0 & 0 & 0 & 1 \end{pmatrix} * \begin{pmatrix} f_x & 0 & 0 & c_x \\ 0 & f_y & 0 & c_y \\ 0 & 0 & 1 & 0 \\ 0 & 0 & 0 & 1 \end{pmatrix} * \begin{pmatrix} X/Z \\ Y/Z \\ Z/Z \\ 1 \end{pmatrix}$$

- Position = mirror * translate * scale * camera_projection * world

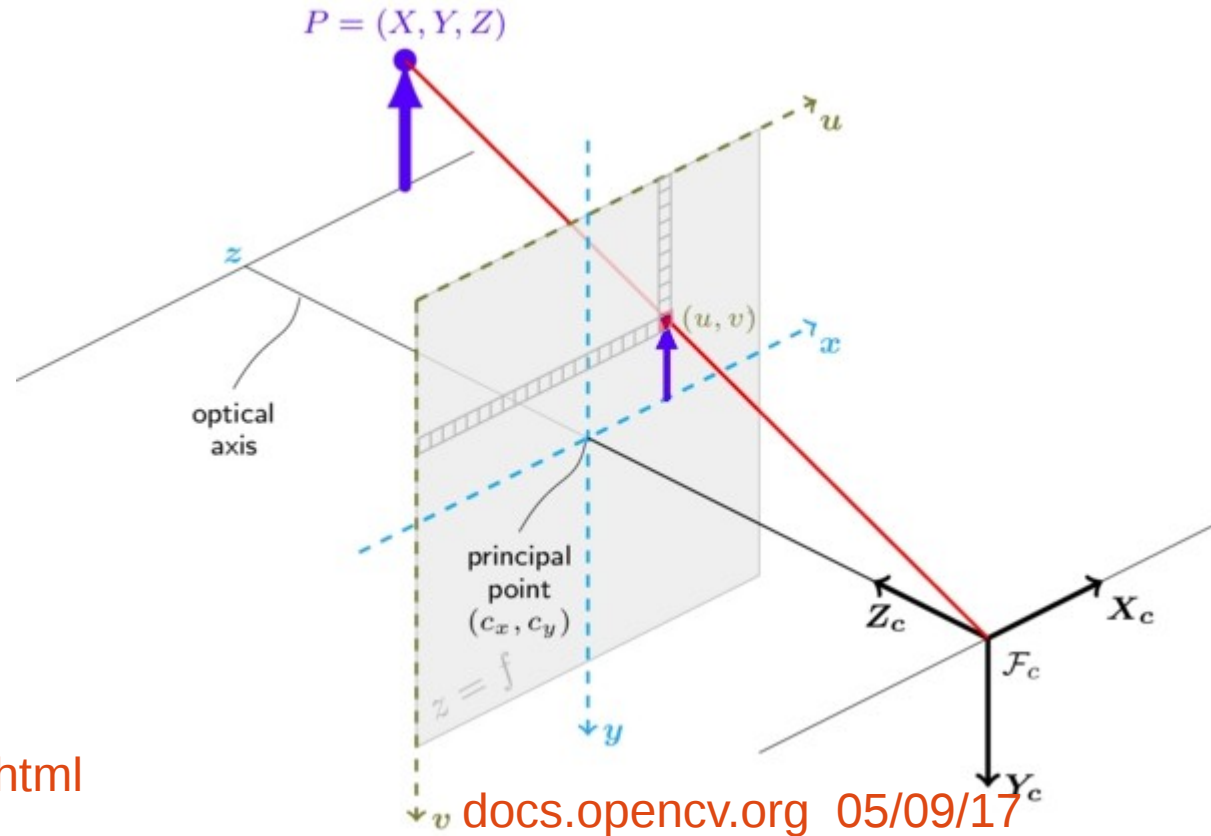
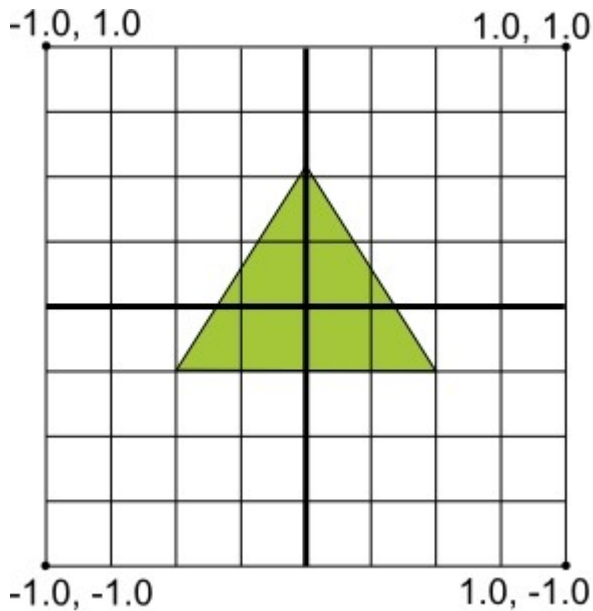

android.com/./opengl.html

docs.opencv.org 05/09/17